



HILTI S-BT SCREW-IN THREADED STUDS

Hilti S-BT Specifications

CONTENT

1	Introduction	5
1.1	Definition	5
1.2	The S-BT system	5
1.2.1	S-BT fastener and designation	5
1.2.2	Drilling tool	6
1.2.3	Stepped drill bit	6
1.2.4	Installation tool	7
1.2.5	S-DG depth gauge with a S-CC calibration card	7
1.2.6	Installation temperature and service temperature	8
1.3	Fastening mechanism	8
1.4	S-BT system features and benefits – simplified fastening to steel	9
2	Applications	10
2.1	Grating fastening system X-FCM and X-FCM NG	10
2.2	Grating fastening system X-FCS-R	13
2.3	S-BT with MM and MQ installation channel system	14
2.4	Fastening instrumentation, junction boxes and lighting	15
2.5	S-BT with Hilti standoff adapter: Fastening instrumentation, junction boxes, lighting, installation channel systems etc.	16
2.5.1	Fastening to steel with a passive fire protection (PFP) coating	16
2.5.2	Fastening to insulated steel members e.g. insulated bulkheads	17
2.6	Fastening cable / conduit connectors	18
2.7	Fastening cable tray supports	18
2.8	Electrical connections	19
2.8.1	Functional bonding and terminal connection in a circuit	20
2.8.2	Protective bonding circuit	21
2.8.3	Lightning protection	22
3	Technical data	23
3.1	Product data	23
3.1.1	S-BT material specifications and dimensions	23
3.1.2	Hilti Coupler material specifications and dimensions	24
3.1.3	Standoff adapter material specifications and dimensions	24
3.1.4	Drilling tool, setting tool, accessories and inserts	25
3.2	Load data	26
3.2.1	Recommended loads	26
3.2.2	Design loads	27
3.2.3	Recommended loads S-BT with Hilti standoff adapter	28
3.2.4	Design loads S-BT with Hilti standoff adapter	29

- 3.2.5 Recommended loads S-BT with Hilti coupler RC-MF and RC-MR 30
- 3.2.6 Design loads S-BT with Hilti coupler RC-MF and RC-MR 30
- 3.2.7 Recommended interaction formula for combined loading – steel and aluminum base materials 31
- 3.2.8 Base material thickness t_{bl} and type of bore hole 31
- 3.2.9 Thickness of fastened material t_f 32
- 3.2.10 Spacing and edge distances 33
- 3.2.11 Installation temperature and service temperature 33
- 3.2.12 Application limit and thickness of base material 34
- 3.2.13 Fastening quality assurance and fastening inspection 34
- 3.2.14 Fastener selection and system recommendation 35
- 3.2.15 Installation details: Fastening S-BT threaded studs with standoff adapter to steel with a passive fire protection (PFP) coating 36
- 3.2.16 Installation details 37
- 4 Method statement 39
 - 4.1 Instruction for use – S-BT-MF M6, M8, M10, W6, W10 39
 - 4.2 Instruction for use – S-BT-MF M8/7 AN 6 40
 - 4.3 Instruction for use – S-BT-MR M6, M8, M10, W6, W10 SN 6 41
 - 4.4 Instruction for use – S-BT-MR M8/7 SN 6 43
 - 4.5 Instruction for use – S-BT-MR M6, M8, M10, W6, W10 SN 6 AL 45
 - 4.6 Instruction for use – S-BT-MR M8/7 SN 6 AL 46
 - 4.7 Instruction for use – S-BT-GF M8/7 AN 6 47
 - 4.8 Instruction for use – S-BT-GR M8/7 SN 6 48
 - 4.9 Instruction for use – S-BT-GR M8/7 SN 6 AL 50
 - 4.10 Instruction for use – S-BT-EF M6/W6/M8 51
 - 4.11 Instruction for use – S-BT-EF M10/W10 52
 - 4.12 Instruction for use – S-BT-ER M6/W6/M8 53
 - 4.13 Instruction for use – S-BT-ER M10/W10 55
 - 4.14 Instruction for use – S-BT-EF W10 HC 4/0 and S-BT-EF M10 HC 120 57
 - 4.15 Instruction for use – S-BT-ER W10 HC 4/0 and S-BT-ER M10 HC 120 58
 - 4.16 Instruction for use – Standoff adapter MF and MR 25/50/75/100 on steel with a passive fire protection (PFP) coating 59
 - 4.16.1 Instruction for use – Calibration of depth gauge S-DG BT for installation of S-BT on PFP-coated steel (e.g. S-BT GR M8/7 SN 6) 59
 - 4.16.2 Instruction for use – Fastening of standoff adapter with S-BT on PFP-coated steel 60
 - 4.17 Instructions for use – Attachments to standoff adapter (e.g. M8) 60
- 5 Performance 61
 - 5.1 Nomenclature and symbols 61
 - 5.2 Design concepts 62
 - 5.3 Static capacity of the S-BT threaded stud 63

5.3.1	Tensile load deformation behaviour of S-BT threaded stud fastenings	63
5.3.2	Pull out strength of S-BT threaded stud fastenings.....	64
5.3.3	Shear strength of S-BT threaded stud fastenings	65
5.4	S-BT in stainless steel base material.....	66
5.5	Vibration effects on S-BT threaded stud fastenings	67
5.6	Resistance of S-BT fastenings under dynamic tensile loading.....	68
5.7	Effect of S-BT threaded stud fastenings on the fatigue strength of the base material structural steel.....	70
5.8	Influence of glue coatings on the loosening torque	79
5.9	S-BT-ER and S-BT-EF screw-in threaded studs for electrical connections	80
5.9.1	Effect of S-BT-ER / S-BT-EF studs on integrity of pipe flange.....	81
5.9.2	Permanent current.....	82
5.9.3	Short circuit current	83
5.9.4	Lightning current.....	85
5.10	Corrosion resistance	86
5.10.1	Selection of a suitable fastener	86
5.10.2	Galvanic (contact) corrosion.....	88
5.10.3	Carbon steel S-BT studs	89
5.10.4	Stainless steel S-BT studs.....	90
5.10.5	Conductivity disc of S-BT-ER / -EF electrical connectors	92
5.10.6	Standoff Adapters.....	92
5.10.7	Hilti Coupler RC-MF and RC-MR	92
5.10.8	X-FCM and X-FCM NG grating fasteners	93
5.11	Fire resistance.....	94
5.12	Volume swelling of SN 12 sealing washer (stainless steel S-BT studs).....	97
6	System program	98
7	Approvals.....	100
7.1	Offshore and Shipbuilding applications.....	100
7.2	Onshore and Industry applications	100

1 INTRODUCTION

1.1 Definition

The S-BT fasteners are threaded studs manufactured from hardened carbon steel 1038 and austenitic-ferritic (Duplex) stainless steel 1.4462 acc. DIN-EN 10088-1 (AISI 316 and 318LN equivalent). The S-BT threaded studs are fasteners with male threads (metric M8 and M10 or inch W10) for attachment on one end and a threaded tip on the other end for embedment into the structural steel or aluminum. Carbon steel studs are supplied with an aluminum sealing washer Ø 10 mm, stainless steel studs are supplied with a stainless-steel sealing washer Ø 12 mm, both with a chloroprene rubber sealing ring.

The S-BT technology can be used as an alternative to the welds and bolts used to attach materials to structural steel and for fastening applications in shipbuilding environment and offshore structures.

The S-BT fastener will be screwed in into a pre-drilled hole. The screw is tapping its own internal mating threads when installed into base material. A special stepped drill bit is needed to guarantee an accurately defined pre-drilled hole in terms of borehole depth and diameter. With this system reliable fastenings can be made in steel with a thickness $3 \text{ mm } [0.12"] \leq t_{II} < 6 \text{ mm } [0.24"]$ and in aluminum with a thickness $5 \text{ mm } [0.20"] \leq t_{II} < 6 \text{ mm } [0.24"]$ in pre-drilled through holes. For base materials steel and aluminum $t_{II} \geq 6 \text{ mm } [0.24"]$ the fastener is intended to be set in a pre-drilled pilot hole. The benefit of pilot holes is no through penetration of the base material. If the real base material thickness t_{II} exceeds $6 \text{ mm } [0.24"]$, no rework of the protective surface coating on the back side is needed. In case of a drill through hole or a pilot hole in thinner base material, rework of the coating on the back side of the plate / profile may be needed. For more details refer to section 3.2.8 "Corrosion information".

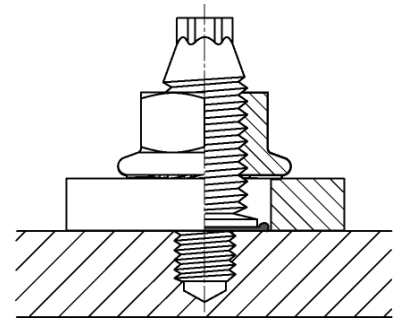

Section of S-BT fastener installed in a pilot hole

1.2 The S-BT system

1.2.1 S-BT fastener and designation

	Stainless steel	Carbon steel
Multipurpose fastening	S-BT-MR M8/7 SN 6	S-BT-MF M8/7 AN 6
	S-BT-MR MT M8/7 SN 6	S-BT-MF MT M8/7 AN 6
	S-BT-MR M8/7 SN 6 AL	S-BT-MF M8/15 AN 6
	S-BT-MR M8/15 SN 6	S-BT-MF M10/15 AN 6
	S-BT-MR M8/15 SN 6 AL	S-BT-MF MT M10/15 AN 6
	S-BT-MR M10/15 SN 6	S-BT-MF W10/15 AN 6
	S-BT-MR MT M10/15 SN 6	
	S-BT-MR M10/15 SN 6 AL	
	S-BT-MR W10/15 SN 6	
	S-BT-MR W10/15 SN 6 AL	
Grating fastening	S-BT-GR M8/7 SN 6	S-BT-GF M8/7 AN 6
	S-BT-GR NG M8/7 SN 6	S-BT-GF NG M8/7 AN 6
	S-BT-GR M8/7 SN 6 AL	
Electrical connections	S-BT-ER M8/15 SN 6	S-BT-EF M8/15 AN 6
	S-BT-ER M10/15 SN 6	S-BT-EF M10/15 AN 6
	S-BT-ER W10/15 SN 6	S-BT-EF W10/15 AN 6
	S-BT-ER M10 HC 120	S-BT-EF M10 HC 120
	S-BT-ER W10 HC AWG4/0	S-BT-EF W10 HC AWG4/0

S	Indication of Product of Hilti Business Area S crew Fastening
BT	B lunt Tip
M, G, E	Indication of application. M ultipurpose fastening, G rating fastening, E lectrical
R, F	Indication of material or coating. R (Rostfrei = Stainless), F (Duplex coated)
NG	N arrow G rating. For gratings with small openings (≥ 13 mm)
MT	Mechanical Trade
M8, M10, W10	Thread type and size
15, 7	Fastening material thickness [mm]
HC	H igh C urrent
SN, AN	Washer type, SN S tainless steel N eoprene, AN A luminum N eoprene
6	Minimum base material thickness for installation in a pilot hole
AL	Indication of type of base material (AL = A luminum)

1.2.2 Drilling tool

Designation	Item Description	Application
SBT 4-A22	UCD tool	Drilling / Setting
SF BT 22-A (B22/2.6 or 5.2Ah)	UCD tool	Drilling
SF BT 18-A (B18/2.6 or 5.2Ah)	UCD tool	Drilling

Regarding the drilling time and the bore hole quality, a special tool with optimized revolutions per minute is needed. The cordless drilling machines SBT 4-A22, SF BT 22-A and SF BT 18-A are optimized for the drilling process in this application.



SBT 4-A22 drilling / setting tool

1.2.3 Stepped drill bit

Designation	Item Description	Application
TS-BT 5.5-74 S	Stepped drill bit for ≥ 3 mm [0.12"] base material thickness	Drilling in steel
TS-BT 5.5-110 S	Stepped drill bit for Narrow Grating	Drilling in steel
TS-BT 5.5-74 AL	Stepped drill bit for ≥ 5 mm [0.20"] base material thickness	Drilling in aluminum



TS-BT 5.5-74 S stepped drill bit

A stepped drill prevents the perforation of the base material ($t \geq 6$ mm [0.24"]) and ensures a proper drilling depth and an accurate bore hole in terms of diameter. The front part generates the pilot hole in the base material in which the self-tapping thread will be set. The step (increased diameter) prevents the drill bit from further movement and through-penetration. Furthermore, the step will create a "shiny-ring" around the hole which allows the installer to recognize the end of the drilling process.

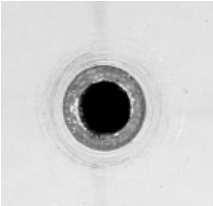

Shiny ring around the bore hole

Each S-BT sales box includes the corresponding TS-BT stepped drill bit. The stepped drill bit typically resists at least 100 bore holes with a constant geometry. Hilti recommends disposing of the used TS-BT stepped drill bit once the complete sales packaging S-BT studs are consumed. Hilti then advises using the new stepped drill bit out of the new sales packaging.



1.2.4 Installation tool

Designation	Item Description	Application
SBT 4-A22	UCD tool	Drilling / Setting
SF 4-A22	UCD tool	Setting
SFC 22-A (B22/2.6 or 5.2Ah)	UCD tool	Setting
SFC 18-A (B18/2.6 or 5.2Ah)	UCD tool	Setting

For the installation process, a recommended torque up to 13 Nm is needed. The cordless drill drivers SBT 4-A22, SF 4-A22, SFC 22-A and S-FC 18-A fulfill the requirements for the installation process.



Hilti UCD SFC 22-A (cordless)

1.2.5 S-DG depth gauge with a S-CC calibration card

Designation	Item Description	Application
S-DG BT M8/7 Short 6	Depth gauge for S-BT M8/7 _N 6	Setting
S-DG BT M8/15 Long 6	Depth gauge for S-BT M8/15 _N 6	Setting
S-DG BT M10-W10/15 Long 6	Depth gauge for S-BT M10/W10 _N 6	Setting
S-DG BT M10-W10 HC 6	Depth gauge for S-BT M10/W10 HC _	Setting
S-CC BT 6	Calibration card for calibration of the depth gauge (short/long studs)	Calibration
S-CC BT HC 6	Calibration card for calibration of the depth gauge for S-BT M10/W10 HC _	Calibration
S-CG BT /7 Short 6	Check gauge for verification of the standoff for short studs (7 mm)	Verification
S-CG BT /15 Long 6	Check gauge for verification of the standoff for long studs (15 mm)	Verification
S-CG BT HC	Check gauge for verification of the standoff for S-BT M10/W10 HC	Verification



S-DG BT mechanical depth gauge

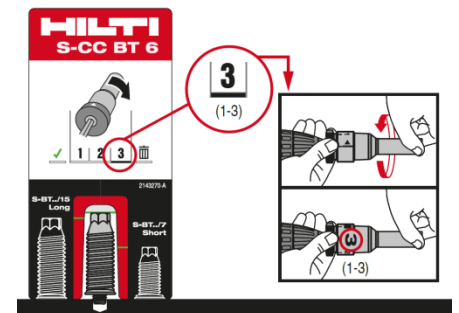

Design and functionality of the mechanical calibration card S-CC BT

In order to ensure the exact screw-in depth and a proper compressed sealing washer, the S-BT studs have to be installed with the appropriate depth gauge. With this tool the screw-in depth can be adjusted in a range of 0 - 1.5 mm (3 steps, 0.5mm per step).

The S-CC BT calibration card is needed to check the initial standoff of the S-BT stud (ensure the proper screw-in depth) and to adjust/calibrate the S-DG depth gauge. After finding the right adjustment level for the S-DG depth gauge, the gauge can be adjusted and the studs can be installed without additional check of the S-DG depth gauge.

The depth gauge has to be re-adjusted (calibrated) at following times:

- Start of the installation process
- Change of the working position (upwards, downwards, horizontal) and base material (thickness, strength, type)
- Installer change
- After each packaging respectively after the installation of 100 S-BT studs



Design and functionality of the check gauge S-CG BT

Section 4 comprises the instructions for use (IFU) of the S-BT studs with a detailed illustration how to use the S-DG depth gauge and the S-CC calibration card. The installer is responsible for the correct setting of the S-BT studs. For the periodical verification of the correct stud standoff the S-CG BT check gauge can be used.

The lifetime of the S-DG BT depth gauge is ≥ 1000 settings.



1.2.6 Installation temperature and service temperature

The **installation temperature** is the temperature at which the S-BT studs are installed. A distinction is made between the temperature of the base material and the temperature of the S-BT studs, drilling and installation tools and accessories. The installation temperature range can be found in the table below.

The **service temperature** is the temperature at which the S-BT studs operate. The S-BT studs will operate effectively and without any loss in performance (loads, sealing function, etc.) within the specified service temperature range. Outside this temperature range the S-BT studs may fail.

	Installation temperature		Service temperature	
	min	max	min	max
Base material	-40 °C	+60 °C	-40 °C	+100 °C
S-BT studs	-10 °C	+60 °C	-40 °C	+100 °C
Drilling & installation tools and accessories	-10 °C	+60 °C	n.a.	n.a.

Note:

- The service temperature range of the connected cable lugs and cables has to be observed. For details please contact the supplier of the cable lugs and cables.
- When using Hilti S-BT fasteners in combination with fire rated boundaries in Shipbuilding facilities, the max. service temperature for a period of 60 minutes is higher. For more details refer to section 5.11 “Fire resistance”.

1.3 Fastening mechanism

The S-BT fastener will be screwed in into a pre-drilled hole. The threaded stud is tapping its own internal mating threads when installed into base material. The S-BT fasteners are anchored in the base material by way of a keying effect, i.e. self-tapping screws form a thread in the base material. The ground cross-sections of an S-BT fastener in steel shows the thread of the fastener engaged with the base material.



Fastening mechanism S-BT stud

1.4 S-BT system features and benefits – simplified fastening to steel

No rework:

Stud welding or through-bolting, for example, may require reworking of the protective surface coating. With the S-BT system, the stud is set into a small pre-drilled hole. In case of a pilot hole the drill entry point is then completely sealed by the stud washer during setting. If the real base material thickness t_{II} exceeds 6 mm [0.24"], no rework of the protective surface coating on the back side is needed.

Simple and fast:

A minimal amount of training is all that is required for a user to be able to install up to 100 studs per hour.

High corrosion resistance:

The stainless steel S-BT fasteners are made from the duplex stainless steel type 1.4462, which is equivalent to AISI 316 (A4) and 318LN steel grade and suitable for aggressive environments like in coastal and offshore applications.

The coating of the carbon steel S-BT fasteners consists of an electroplated Zn-alloy for cathodic protection and a top coat for chemical resistance (Duplex-coating). The use of this coating is limited to indoor environments and outdoor (no coastal) environments with low pollution. Refer to section 5.10 for selection of the suitable fastener in terms of corrosion.

High tension and shear load values:

S-BT delivers performance comparable to methods such as stud welding. See load data tables in section 3.2 for details.

Fasten to all steel shapes:

Unlike clamps, which are limited by the configuration of the base steel, the S-BT is ideal for use on hollow sections, channel sections, wide flanges and angles.

Fasten to thin steel and aluminum:

In addition to fastening to standard construction steel $t_{II} \geq 6 \text{ mm [0.24"]}$ (pilot hole), the S-BT can also be used to fasten to aluminum $t_{II} \geq 6 \text{ mm [0.24"]}$ (pilot hole) and $5 \text{ mm [0.20"]} \leq t_{II} < 6 \text{ mm [0.24"]}$ (drill through hole). Furthermore, fastening in thin steel $3 \text{ mm [0.12"]} \leq t_{II} < 6 \text{ mm [0.24"]}$ (drill through hole) is possible. In case of a drill through hole, rework of the coating on the back side of the plate / profile may be needed.

Cordless and Portable:

The cordless drilling and installation tools eliminate the need for electrical cords and heavy welding equipment.

No through-penetration for base material thickness $t_{II} \geq 6 \text{ mm [0.24"]}$:

The special process of drilling and installation results in secure fastening of the fastener without through-penetration of the base material. If the real base material thickness t_{II} exceeds 6 mm [0.24"], no rework of the protective surface coating on the back side is needed.



Rework



Corrosion



Loosening

2 APPLICATIONS

2.1 Grating fastening system X-FCM and X-FCM NG

X-FCM, X-FCM-M, X-FCM-M_L and X-FCM-M NG grating discs for use with S-BT-GF M8/7 or S-BT-GR M8/7

X-FCM-R and X-FCM-R NG grating discs (stainless steel) for use with S-BT-GR M8/7

A fastening system designed for attaching metal or fiber-glass grating to coated steel

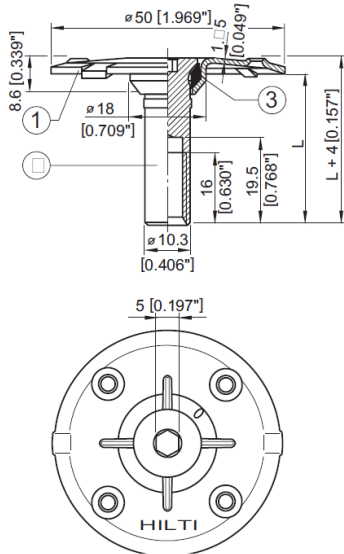

X-FCM, X-FCM-M, X-FCM-R grating discs

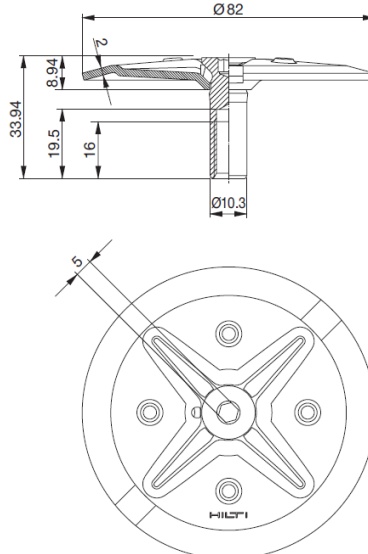

X-FCM-M_L grating disc

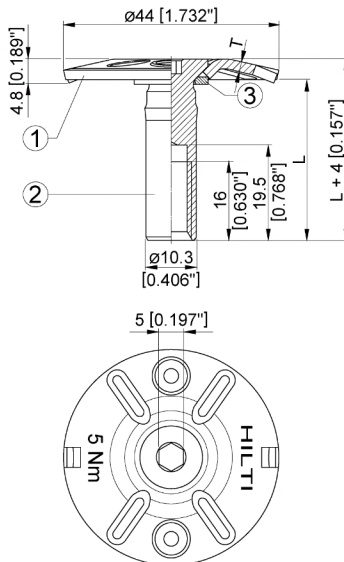
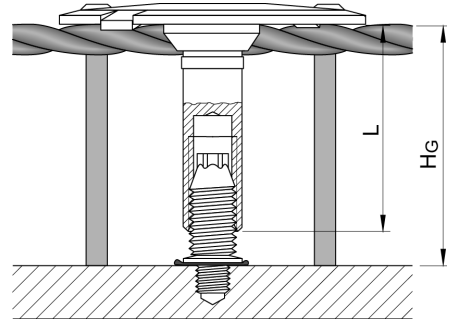
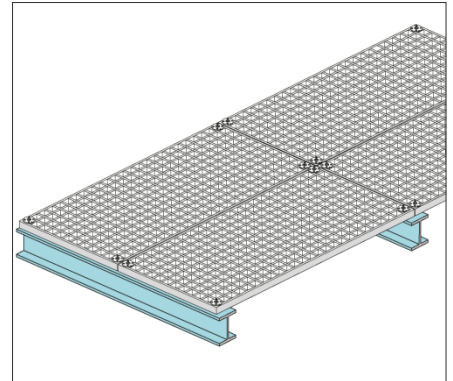

X-FCM-M NG, X-FCM-R NG grating disc



Important: The X-FCM, X-FCM-M, X-FCM-R, X-FCM-M_L, X-FCM-M NG and X-FCM-R NG systems are not designed or intended to resist shear loads.

X-SEA-R 30 M8 extension adaptor

For use with X-FCM-R and X-FCM-R NG grating fasteners for fastening of grating with a height in excess of 50 mm [1.97"].

Fastener Selection X-FCM

Designation	L [mm/in.]	Grating height HG, range [mm/in.]	Grating height with X-SEA-R 30 M8 [mm/in.]
X-FCM-R 25/30	23/0.91	25-30/0.98-1.18	55-60/2.16-2.36
X-FCM-R 1"-1¼"	27/1.06	29-34/1.14-1.34	59-64/2.32-2.52
X-FCM-R 35/40	33/1.30	35-40/1.38-1.57	65-70/2.56-2.75
X-FCM-R 45/50	43/1.69	45-50/1.77-1.97	75-80/2.91-3.15
X-FCM-M 25/30	23/0.91	25-30/0.98-1.18	
X-FCM-M 1"-1¼"	27/1.06	29-34/1.14-1.34	
X-FCM-M 35/40	33/1.30	35-40/1.38-1.57	
X-FCM-M 45/50	43/1.69	45-50/1.77-1.97	
X-FCM-M 31/36 L*)	25/0.98	31-36/1.22-1.42	

*) Grating height HG 31 mm and 32 mm: Use with S-BT-GF M8/7 or S-BT-GR M8/7
Grating height HG 33 mm to 36 mm: Use with S-BT-MF M8/15 or S-BT-MR M8/15

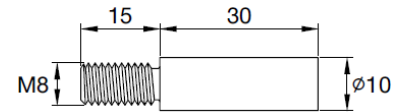

X-SEA-R 30 M8 extension adaptor

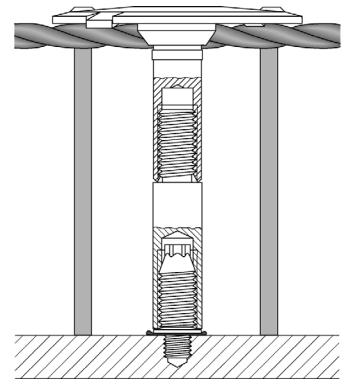

Installation instructions X-FCM

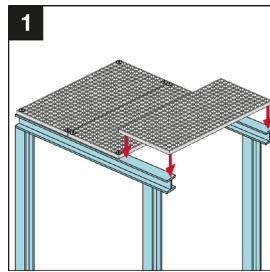

1 Lay grating section in final position.

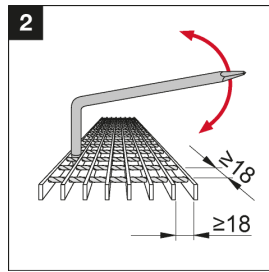

2 Expand grating openings if necessary.

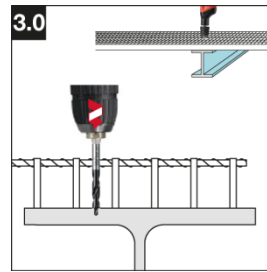

3.0 Pre-drill with TS-BT stepped drill bit.

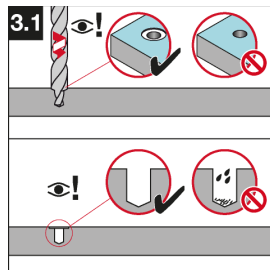

3.1 Pre-drill until shoulder grinds a shiny ring. The drilled hole and the area around drilled hole must be clean and free from liquids and debris.

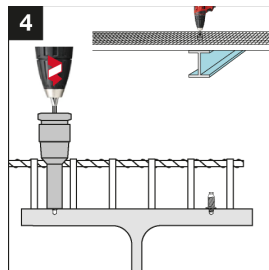

4 Screw-in S-BT studs into drilled hole.

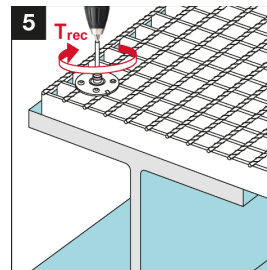

5 Tighten X-FCM discs with 5 mm Allen-type bit with the suited installation torque.

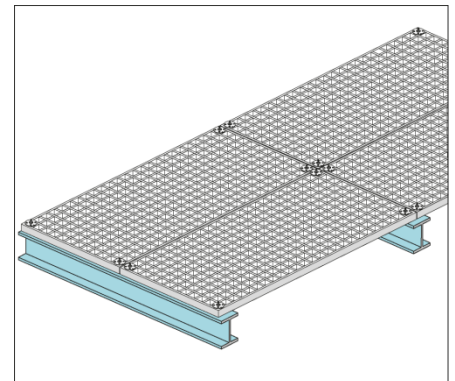

Fastener Selection X-FCM NG

Designation	L [mm/in.]	Grating height HG, range [mm/in.]	Grating height with X-SEA-R 30 M8 [mm/in.]
X-FCM-R NG 28/33	23/0.91	28-33/1.10-1.30	58-63/2.28-2.48
X-FCM-R NG 32/37	27/1.06	32-37/1.26-1.46	62-67/2.44-2.64
X-FCM-R NG 38/43	33/1.30	38-43/1.50-1.69	68-73/2.68-2.87
X-FCM-R NG 48/53	43/1.69	48-53/1.89-2.09	78-83/3.07-3.27
X-FCM-M NG 28/33	23/0.91	28-33/1.10-1.30	
X-FCM-M NG 32/37	27/1.06	32-37/1.26-1.46	
X-FCM-M NG 38/43	33/1.30	38-43/1.50-1.69	
X-FCM-M NG 48/53	43/1.69	48-53/1.89-2.09	

Installation instructions X-FCM NG

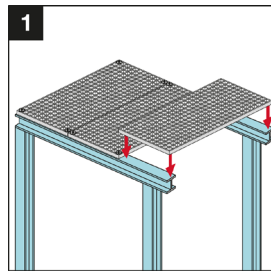

1 Lay grating section in final position.

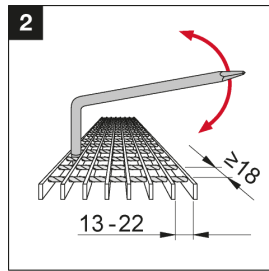

2 Expand grating openings if necessary.

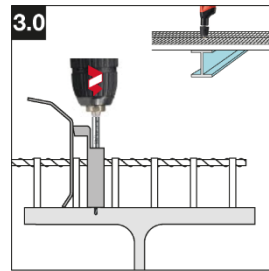

3.0 Pre-drill with TS-BT 5.5-110 S stepped drill bit and S-CS NG centering spacer.

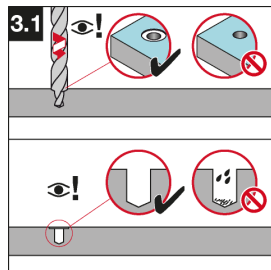
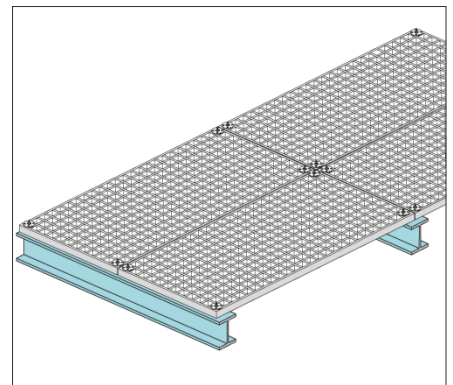

3.1 Pre-drill until shoulder grinds a shiny ring. The drilled hole and the area around drilled hole must be clean and free from liquids and debris.

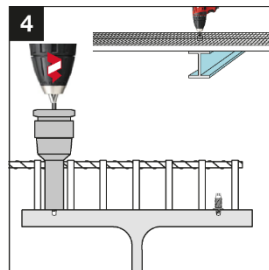

4 Screw-in S-BT studs into drilled hole.

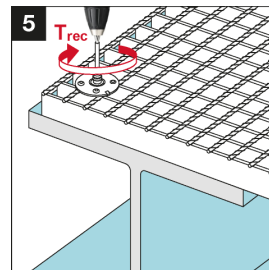

5 Tighten X-FCM NG discs with 5 mm Allen-type bit with the suited installation torque.

Important notes:

These are abbreviated instructions which may vary by application. ALWAYS review / follow the instructions for use (IFU) accompanying the product. In case of a **drill through hole**, rework of the coating on the back side of the plate / profile may be needed.

2.2 Grating fastening system X-FCS-R

X-FCS-R grating fastener for use with S-BT-GR M8/7

The X-FCS-R system is a fastening system for grating fastening with tensile and shear resistance capability (shear relevant zones).

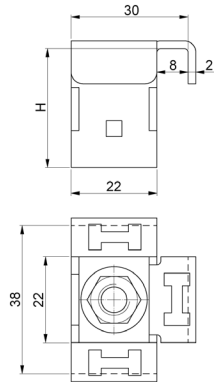

X-FCS-R-3-25 grating fastener

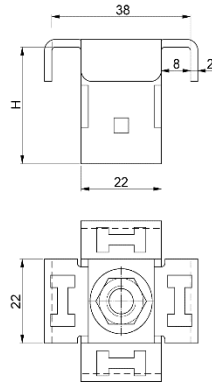

X-FCS-R-4-25 grating fastener

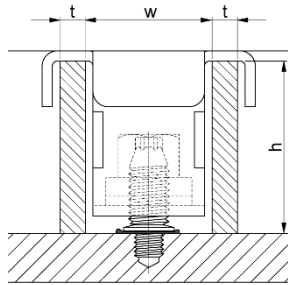
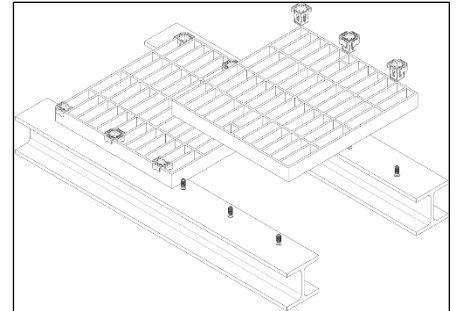

X-FCS-R-4-25 grating fastener

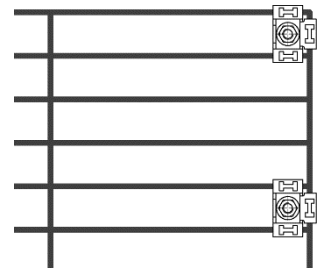
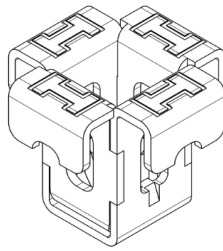

X-FCS-R-3-25 for rectangular gratings

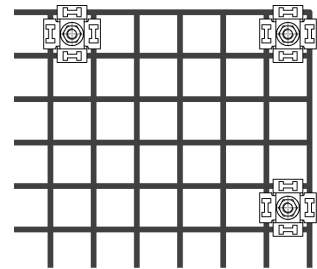

X-FCS-R-4-25 for square gratings

Fastener Selection

Designation	Fastener height H [mm/in.]	Grating height h, range [mm/in.]
X-FCS-R-3-25 31/35	30.5/1.20	31-35/1.22-1.38
X-FCS-R-3-25 37/41	36.5/1.44	37-41/1.46-1.61
X-FCS-R-4-25 31/35	30.5/1.20	31-35/1.22-1.38
X-FCS-R-4-25 37/41	36.5/1.44	37-41/1.46-1.61

Important: The X-FCS-R system is suitable for rectangular gratings and square gratings with a bar spacing $w = 25 \text{ mm}$ [0.98"] and bar thickness $t = 5 \text{ mm}$ [0.20"].

Tightening torque X-FCM, X-FCM NG discs and X-FCS-R grating fastener

$T_{\text{rec}} = \text{max. } 8 \text{ Nm}$
 $T_{\text{rec}} = \text{max. } 5 \text{ Nm}^1)$

¹⁾- for X-FCM-M NG

- for S-BT-GR M8/7 SN 6 and S-BT-GF M8/7 AN 6 in steel base material with thickness $3 \text{ mm} \leq t_{\text{fl}} < 5 \text{ mm}$ (drill through hole)
- for S-BT-GR M8/7 SN 6 AL in aluminium base material

2.3 S-BT with MM and MQ installation channel system

MM channel system for use with S-BT-MF

MQ channel system for use with S-BT-MF or S-BT-MR

Installation instructions

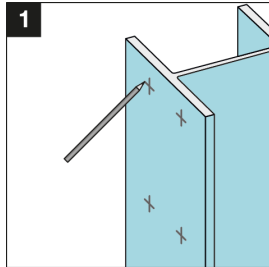

1 Mark location of each fastening.

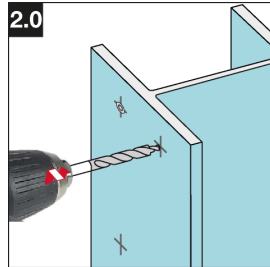

2.0 Pre-drill with **TS-BT** stepped drill bit.

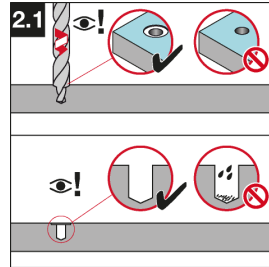

2.1 Pre-drill until shoulder grinds a shiny ring. The drilled hole and the area around drilled hole must be clean and free from liquids and debris.

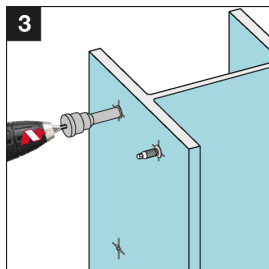

3 Screw-in S-BT studs into drilled hole.

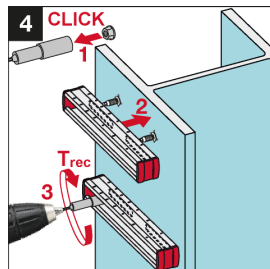

4 **CLICK**
1
2
3 T_{rec}
Position channel on S-BT studs and hold in place. Tighten the nuts with the suited installation torque.

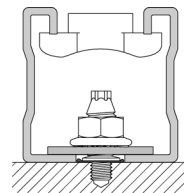
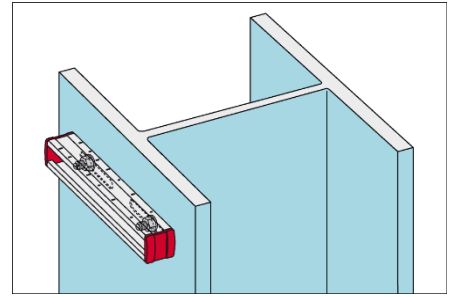

Note: In case of applied shear load, the S-BT should be placed according to illustration (end of slotted hole)

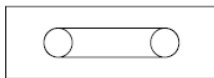

Two **S-BT** studs in one slotted hole



One **S-BT** stud in each slotted hole

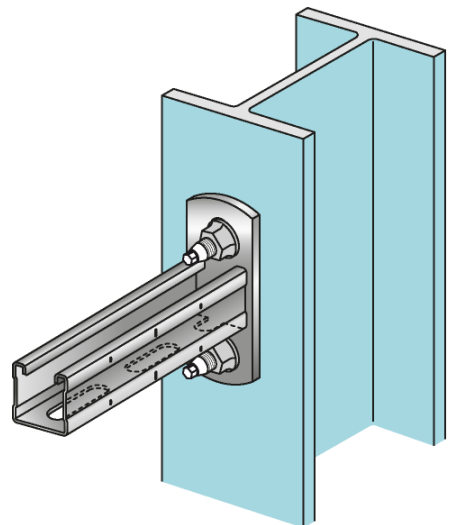

2.4 Fastening instrumentation, junction boxes and lighting

S-BT screw-in threaded studs for attaching instrumentation, junction boxes and lighting to coated steel

Installation instructions

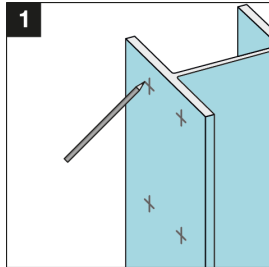

1 Mark location of each fastening.

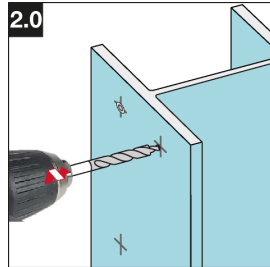

2.0 Pre-drill with **TS-BT** stepped drill bit.

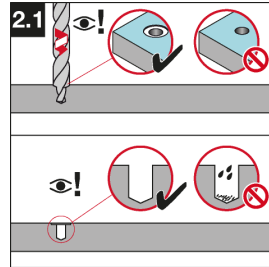

2.1 Pre-drill until shoulder grinds a shiny ring. The drilled hole and the area around drilled hole must be clean and free from liquids and debris.

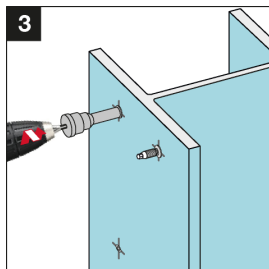

3 Screw-in S-BT studs into drilled hole.

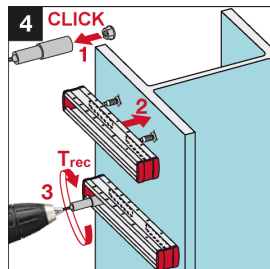

4 **CLICK** Position channel on S-BT studs and hold in place. Tighten the nuts with the suited installation torque.

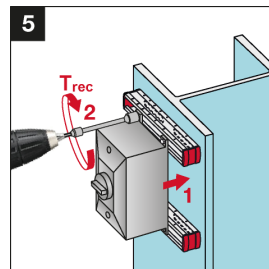

5 Fasten the accessory on the channel with the suited installation torque.

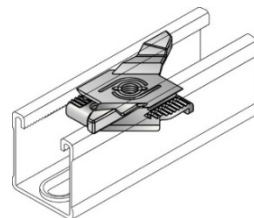
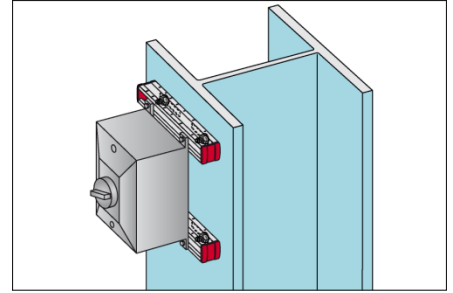

MM Channel System with wing nut M6, M8, M10

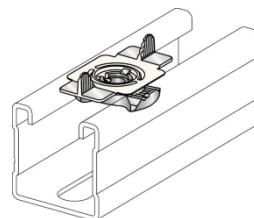

MQ Channel System with wing nut M6, M8, M10, M12, 1/4", 3/8"

For fastening the accessory on the Hilti channel or bracket always use the suitable Hilti wing nut in combination with a proper bolt. The instruction for use (IFU) accompanying the sales packaging of the Hilti wing nuts comprises detailed information about the installation of the wing nut and the tightening torque T_{rec} .

Important notes:

These are abbreviated instructions which may vary by application. ALWAYS review / follow the instructions for use (IFU) accompanying the product. In case of a **drill through hole**, rework of the coating on the back side of the plate / profile may be needed.

2.5 S-BT with Hilti standoff adapter: Fastening instrumentation, junction boxes, lighting, installation channel systems etc.

2.5.1 Fastening to steel with a passive fire protection (PFP) coating

Installation instructions

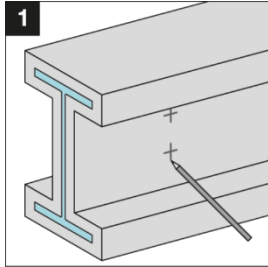

1 Mark location of each fastening.

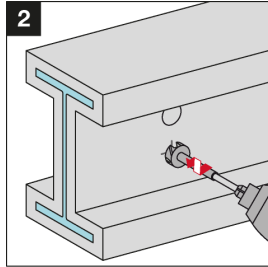

2 Remove PFP and pre-drill with **TS-BT 31-74 PFP** stepped drill bit ...

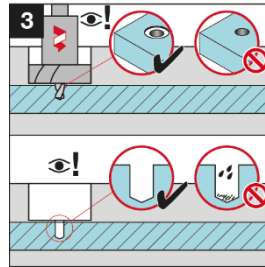

3 ... until shoulder grinds a shiny ring. The area must be clean and free from liquids and debris.

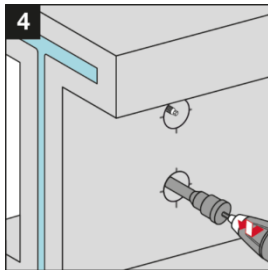

4 Set **S-BT** studs into drilled hole using the **S-DG BT** depth gauge.

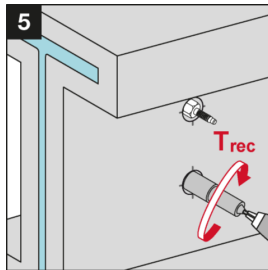

5 Tighten the standoff adapter with the recommended installation torque T_{rec} of **8 Nm**.

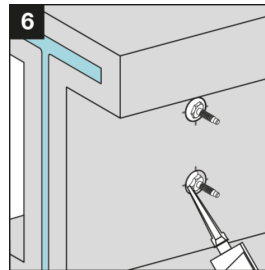

6 Close the opening within 4 hours of the opening is being made in accordance to the patching instructions by the PFP-manufacturer.

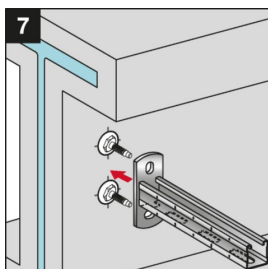

7 Position accessory on standoff adapter and hold in place. Use of **MQZ** bore plate as needed for strut applications.

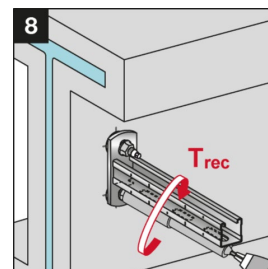

8 Fasten the accessory on the standoff adapter with the recommended installation torque T_{rec} of **20 Nm**.

Important notes:

These are abbreviated instructions which may vary by application. ALWAYS review / follow the instructions for use (IFU) accompanying the product

2.5.2 Fastening to insulated steel members e.g. insulated bulkheads

Installation instructions

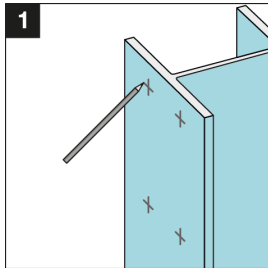

1
Mark location of each fastening.

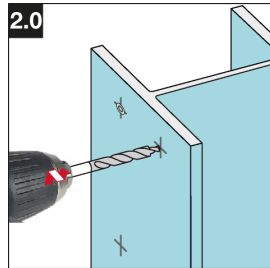

2.0
Pre-drill with **TS-BT** stepped drill bit.

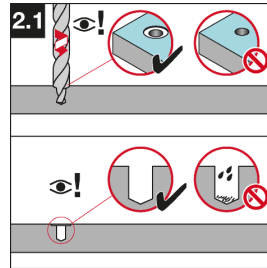

2.1
Pre-drill until shoulder grinds a shiny ring. The drilled hole and the area around drilled hole must be clean and free from liquids and debris.

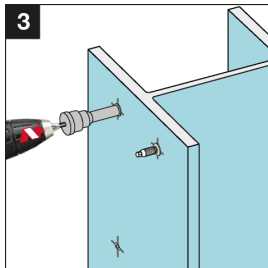

3
Screw-in S-BT studs into drilled hole.

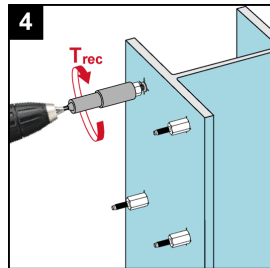

4
Screw-on the Hilti standoff adapter on the S-BT stud and tighten it with the suited installation torque.

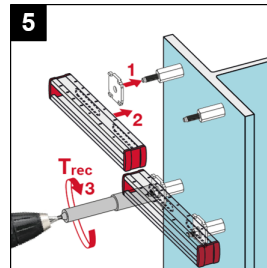

5
Position channel on standoff adapter and hold in place. Tighten the nuts with a tightening torque T_{rec} of **20 Nm**.

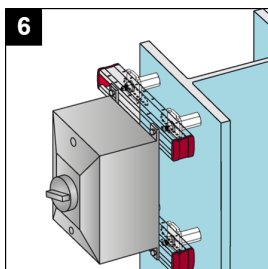

6
Fasten the accessory on the channel with the suited installation torque.

Tightening torque (standoff adapter on S-BT)

$T_{rec} = 8 \text{ Nm}$
 $T_{rec} = 5 \text{ Nm}^{1)}$

¹⁾ for steel base material thickness $3 \text{ mm} \leq t_{II} < 5 \text{ mm}$

Tightening torque (nut on standoff adapter)

$T_{rec} = 20 \text{ Nm}$

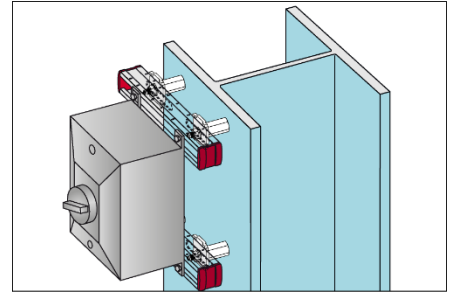
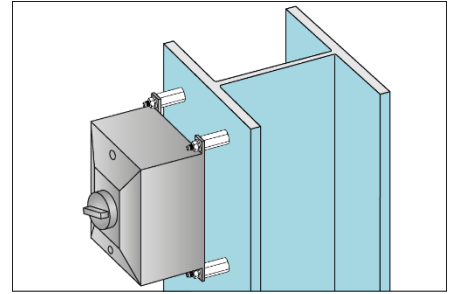

Important notes:

These are abbreviated instructions which may vary by application. ALWAYS review / follow the instructions for use (IFU) accompanying the product. In case of a **drill through hole**, rework of the coating on the back side of the plate / profile may be needed.

2.6 Fastening cable / conduit connectors

Stainless steel and carbon steel S-BT screw-in threaded studs for fastening cable and conduit connectors (T-bars) to coated steel.

Installation instructions

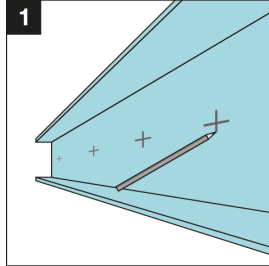

1 Mark location of each fastening.

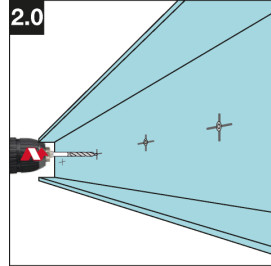

2.0 Pre-drill with **TS-BT** stepped drill bit.

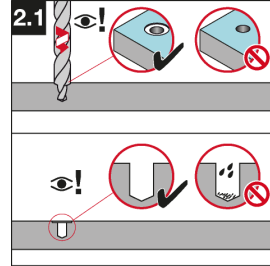

2.1 Pre-drill until shoulder grinds a shiny ring. The drilled hole and the area around drilled hole must be clean and free from liquids and debris.

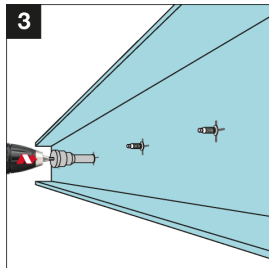
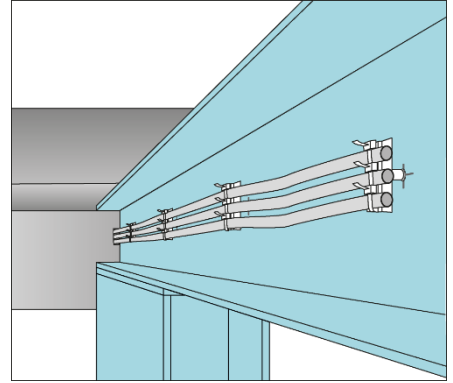

3 Screw-in S-BT studs into drilled hole.

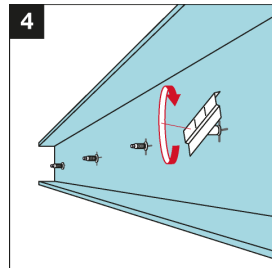

4 Screw on the connector and hand tighten.

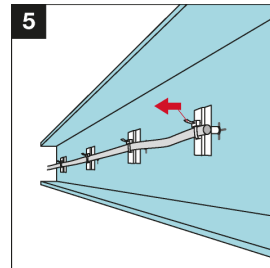

5 Align connectors. Fasten the cable / conduit on the connector.

2.7 Fastening cable tray supports

Stainless steel and carbon steel threaded studs for fastening cable trays to coated steel.

Installation instructions

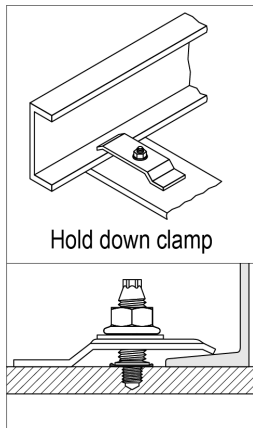

Hold down clamp

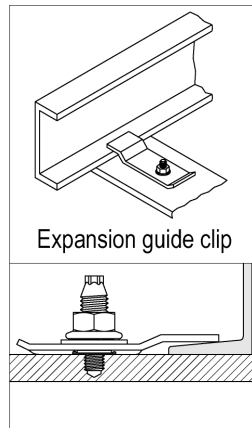

Expansion guide clip

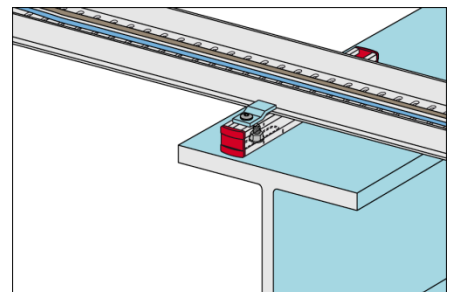
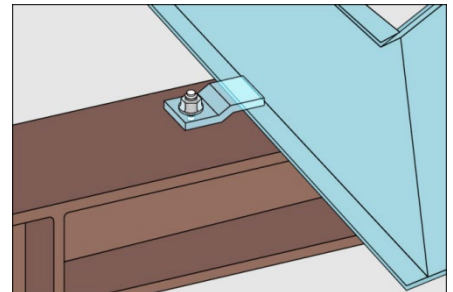

Important notes:

These are abbreviated instructions which may vary by application. ALWAYS review / follow the instructions for use (IFU) accompanying the product. In case of a **drill through hole**, rework of the coating on the back side of the plate / profile may be needed.

2.8 Electrical connections

	Stainless steel S-BT-ER	Carbon steel S-BT-EF
Threaded shank	① Stainless steel S31803, AISI 318LN, (1.4462)	② Carbon steel 1038
Washer	zinc-coated ③ SN 12-R Ø 12mm [0.47"]	duplex-coated" ④ AN 10-F Ø 10mm [0.39"]
Nut	Stainless steel S31603, AISI 316L, (1.4404)	Aluminum
Lock washer	⑤ Stainless steel grade A4 – AISI 316 material	⑥ Carbon steel HDG
Conductivity disc	⑦ Stainless steel grade A4 – AISI 316 material	⑧ Carbon steel HDG
Sealing ring of sealing washer	⑨ Ø 32mm [1.260"] (HC 120/AWG4/0) Copper alloy CuSn8 (tin-coated) with sealing ring	
Conductivity discs	Chloroprene rubber CR 3.1107 black, resistant to UV, salt water, water, ozone, oils, etc.	
	FKM, resistant to UV, salt water, water, ozone, oils, etc.	

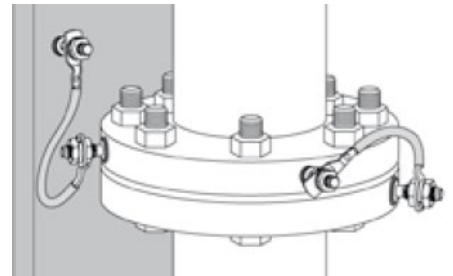

Functional and protective bonding of pipes^{*)} (outer diameter of installed surface ≥ 150mm)

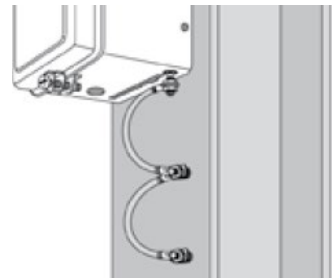

Protective bonding circuit – Double point connection

Fasteners

S-BT-ER M10/15 SN 6
S-BT-ER W10/15 SN 6
S-BT-EF M10/15 AN 6
S-BT-EF W10/15 AN 6

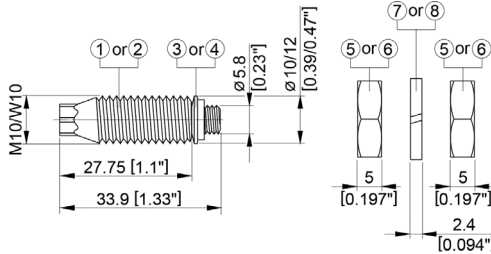

S-BT-ER M8/15 SN 6
S-BT-EF M8/15 AN 6

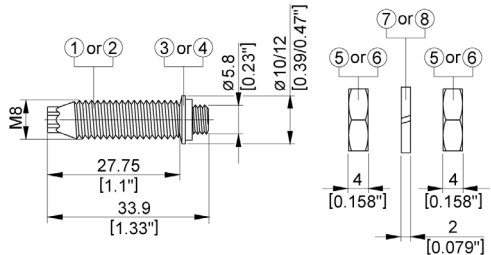

S-BT-ER M10 HC 120
S-BT-ER W10 HC AWG4/0
S-BT-EF M10 HC 120
S-BT-EF W10 HC AWG4/0

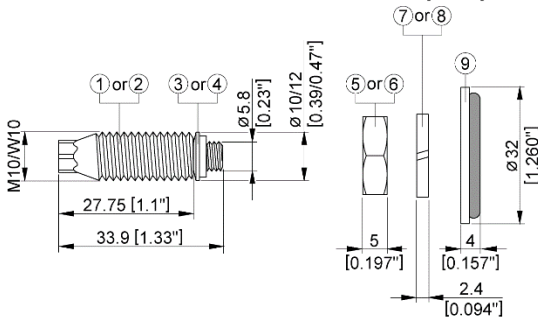

Please refer to section 5.9.1 for additional technical information with regards to the effect of S-BT-ER / S-BT-EF fasteners on integrity of pipe flange.

^{*)} only for Type A cable connections

2.8.1 Functional bonding and terminal connection in a circuit

For permanent current (leakage current) due to static charge built up in pipes or when closing an electrical circuit.

Single point connection:

Recommended electrical connectors:	Maximum allowable permanent current	Connection configuration
------------------------------------	-------------------------------------	--------------------------

Type A connection

- S-BT-ER M10/15 SN 6
- S-BT-ER W10/15 SN 6
- S-BT-EF M10/15 AN 6
- S-BT-EF W10/15 AN 6
- S-BT-ER M8/15 SN 6
- S-BT-EF M8/15 AN 6

$I_{th} = 57 \text{ A}$

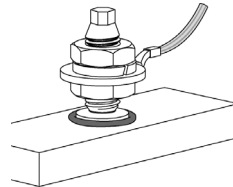

Type B connection

- S-BT-ER M10 HC 120
- S-BT-ER W10 HC AWG4/0
- S-BT-EF M10 HC 120
- S-BT-EF W10 HC AWG4/0

$I_{th} = 269 \text{ A}$

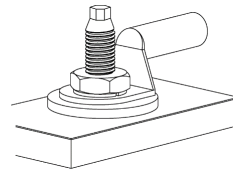

Note:

- Recommended maximal cross section of connected cable according IEC 60947-7-2 and IEC 60947-7-1:
 10 mm² (8 AWG) copper (tested permanent current $I_{th} = 57 \text{ A}$)
 120 mm² (4/0 AWG) copper (tested permanent current $I_{th} = 269 \text{ A}$)
- Fastening of thicker cable is acceptable, if the maximum allowable permanent current I_{th} is not exceeded and the provisions on cable lug thickness t_{cl} are observed.

2.8.2 Protective bonding circuit

For discharging short circuit current while protecting electrical equipment or earth / ground cable trays and ladders.

Single point connection:

Recommended electrical connectors:	Max. short circuit current according to IEC and UL	Connection configuration
------------------------------------	--	--------------------------

Type A connection

- S-BT-ER M10/15 SN 6
- S-BT-ER W10/15 SN 6
- S-BT-EF M10/15 AN 6
- S-BT-EF W10/15 AN 6
- S-BT-ER M8/15 SN 6
- S-BT-EF M8/15 AN 6

$I_{cw} = 1.20 \text{ kA (IEC)}$
 $I_{cw} = 0.75 \text{ kA (UL)}$

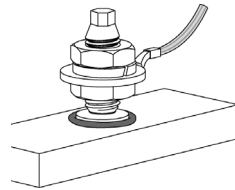

Type B connection with Hilti standoff adapter

- S-BT-ER M10 HC 120
- S-BT-EF M10 HC 120

$I_{cw} = 1.20 \text{ kA (IEC)}$



Type B connection

- S-BT-ER M10 HC 120
- S-BT-ER W10 HC AWG4/0
- S-BT-EF M10 HC 120
- S-BT-EF W10 HC AWG4/0

$I_{cw} = 14.40 \text{ kA (IEC)}$
 $I_{cw} = 10.10 \text{ kA (UL)}$

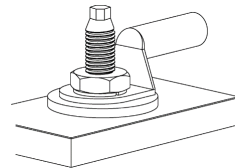

Note:

- Recommended maximal cross section of connected cable according **IEC 60947-7-2 and IEC 60947-7-1**:
 - 10 mm² (8 AWG) copper (tested short circuit current $I_{cw} = 1.20 \text{ kA}$ for 1 s)
 - 120 mm² (4/0 AWG) copper (tested short circuit current $I_{cw} = 14.40 \text{ kA}$ for 1 s)
- according **UL 467**:
 - 10 AWG copper (tested short circuit current $I_{cw} = 0.75 \text{ kA}$ for 4 s)
 - 4/0 AWG copper (tested short circuit current $I_{cw} = 10.10 \text{ kA}$ for 9 s)
- Fastening of thicker cable is acceptable, if the maximum short circuit current I_{cw} and the exposure time is not exceeded and the provisions on cable lug thickness t_{cl} are observed.

3 TECHNICAL DATA

3.1 Product data

3.1.1 S-BT material specifications and dimensions

	Stainless steel	Carbon steel
	S-BT-MR	S-BT-MF
	S-BT-GR	S-BT-GF
Threaded shank	① Stainless steel (X2CrNiMoN22-5-3) S31803, (1.4462)	② Carbon steel 1038
Washer	zinc-coated ③ SN 12-R Ø 12mm [0.47"] Stainless steel (X2CrNiMo 17-12-2) S31603 (1.4404)	duplex-coated ④ AN 10-F Ø 10mm [0.39"] Aluminum (EN AW-5754)
Serrated flange nut	⑤ Stainless steel grade A4 - 70/80	⑥ Carbon steel HDG, grade 8
Sealing washer	③ or ④ Chloroprene rubber CR 3.1107, black, resistant to UV, salt water, water, ozone, oils, etc.	

- S-BT-MR M10/15 SN 6
- S-BT-MR MT M10/15 SN 6^{*)}
- S-BT-MR M10/15 SN 6 AL^{**)}
- S-BT-MR W10/15 SN 6
- S-BT-MR W10/15 SN 6 AL^{**)}
- S-BT-MF M10/15 AN 6
- S-BT-MF MT M10/15 AN 6^{*)}
- S-BT-MF W10/15 AN 6

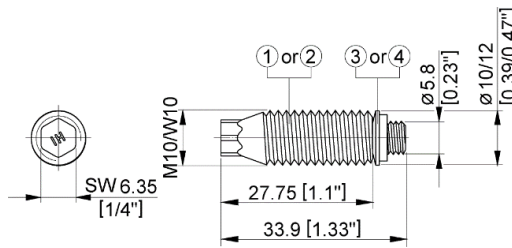

- S-BT-MR M8/7 SN 6
- S-BT-MR MT M8/7 SN 6^{*)}
- S-BT-MR M8/7 SN 6 AL^{**)}
- S-BT-GR M8/7 SN 6^{*)}
- S-BT-GR NG M8/7 SN 6^{*)}
- S-BT-GR M8/7 SN 6 AL^{**)*)}
- S-BT-MF M8/7 AN 6
- S-BT-MF MT M8/7 AN 6^{*)}
- S-BT-GF M8/7 AN 6^{*)}
- S-BT-GF NG M8/7 AN 6^{*)}

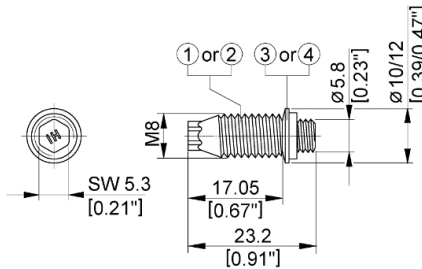

- S-BT-MR M8/15 SN 6
- S-BT-MR M8/15 SN 6 AL^{**)*)}
- S-BT-MF M8/15 AN 6

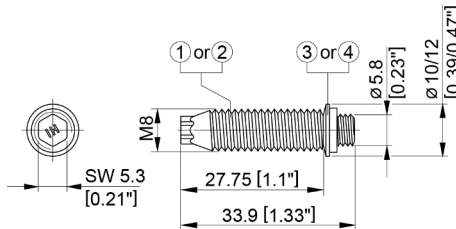

^{*)} Package does not include serrated flange nuts

^{**)*)} for use in aluminum base material

Serrated flange nut

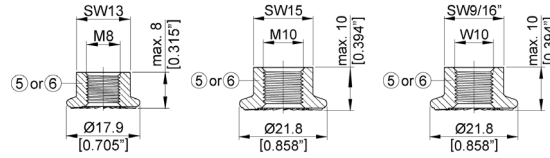

3.1.2 Hilti Coupler material specifications and dimensions

	Stainless steel MR M8, MR M10	Carbon steel MF M8, MF M10
Hilti Coupler	Stainless steel (X5CrNiMo17-12-2) 1.4401-AISI 316 or (X2CrNiMo17-12-2) 1.4404-AISI 316L	Carbon steel (11SMnPb37+C) duplex-coated

RC-MF-M8
RC-MR-M8

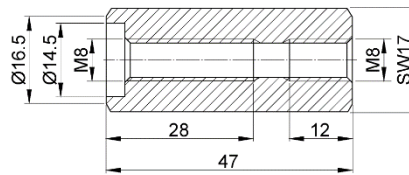

RC-MF-M10
RC-MR-M10

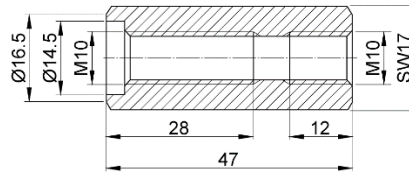

3.1.3 Standoff adapter material specifications and dimensions

	Stainless steel MR 25/50/75/100	Carbon steel MF 25/50/75/100
Adapter	① Stainless steel (X5CrNiMo17-12-2) 1.4401-AISI 316	② Carbon steel (11SMnPb37+C) duplex-coated
Serrated wide flange nut	⑤ Stainless steel grade A4 - 70/80	⑥ Carbon steel HDG, grade 8

Adapter M8-MR 25
Adapter M8-MR 50
Adapter M8-MR 75
Adapter M8-MR 100
Adapter M8-MF 25
Adapter M8-MF 50
Adapter M8-MF 75
Adapter M8-MF 100

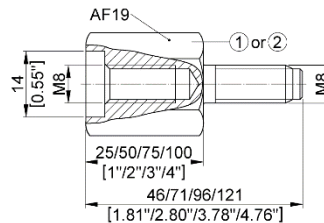

Adapter M10-MR 50
Adapter M10-MF 50
Adapter W10-MR 50
Adapter W10-MF 50

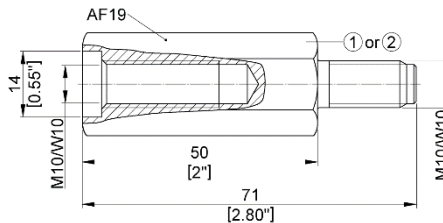

Serrated flange nut

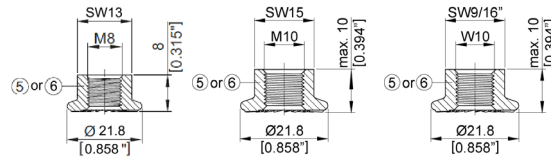

3.1.4 Drilling tool, setting tool, accessories and inserts

For more details refer to section 3.2.14 “Fastener selection and system recommendation”.

Approvals:

EOTA: ETA-20/0530, ICC-ES ESR-4185, ABS: 16-HS1550085-PDA,
 DNV-GL: TAS00000N6, LR: 16/00063, BV 45116/A BV, Russian Maritime
 Register of Shipping: 18.40040.250, RINA: FPE278318CS,
 UL: File E257069, China Classification Society CCS: NJ17P2016



The S-BT fastening system holds several Type Approvals internationally valid for the ship-building and off-shore industry. These approvals are issued by international classification bodies relevant for these industries.

These bodies are:

- ABS - American Bureau of Shipping
- DNV-GL
- LR - Lloyds Register
- BV - Bureau Veritas
- Russian Maritime Register of Shipping
- RINA Services S.p.A.
- CCS - China Classification Society

The UL-listing (File E257069) addresses the use of S-BT-ER / -EF, S-BT-ER / -EF HC and X-BT-ER as grounding and bonding equipment.

The ETA-20/0530 and ICC-ES ESR-4185 address the use of S-BT-MR / -MF and S-BT-GR / -GF for on-shore and industry applications.

Approvals are subject to continuous changes related to code developments, product portfolio updates and new research results. Current approvals can be downloaded from Hilti website or from the websites of most Certification Bodies.

3.2 Load data

3.2.1 Recommended loads

S-BT-MR / S-BT-GR made of stainless steel					
Base material thickness	$t_{II} \geq 5 \text{ mm}$ $t_{II} \geq 0.20''$			$3 \text{ mm} \leq t_{II} < 5 \text{ mm}$ $0.12'' \leq t_{II} < 0.20 \text{ mm}$	
Base material type	Steel S235 A36	Steel S355, S420 Grade 50	Aluminum $R_m \geq 270$ N/mm ²	Steel S235 A36	Steel S355, S420 Grade 50
Tension, N_{rec} [kN/lb]	1.9 / 425	2.3 / 515	1.9 / 425	1.8 / 405	2.1 / 470
Shear, V_{rec} [kN/lb] For edge distance $6 \text{ mm} [0.24''] \leq c < 15 \text{ mm}$ [0.59'']	2.5 / 560	2.8 / 625	2.9 / 650	2.4 / 540	2.5 / 560
Shear, V_{rec} [kN/lb] For edge distance $c \geq 15 \text{ mm} [0.59'']$	4.0 / 895	4.0 / 895	3.5 / 785	3.8 / 850	3.8 / 850
Moment, M_{rec} [Nm/lbft]	11.1 / 8.0				

S-BT-MF / S-BT-GF made of duplex-coated carbon steel					
Base material thickness	$t_{II} \geq 5 \text{ mm}$ $t_{II} \geq 0.20''$			$3 \text{ mm} \leq t_{II} < 5 \text{ mm}$ $0.12'' \leq t_{II} < 0.20 \text{ mm}$	
Base material type	Steel S235 A36	Steel S355, S420 Grade 50	Aluminum $R_m \geq 270$ N/mm ²	Steel S235 A36	Steel S355, S420 Grade 50
Tension, N_{rec} [kN/lb]	2.0 / 450	2.4 / 540	n.a.	1.9 / 425	2.3 / 515
Shear, V_{rec} [kN/lb] For edge distance $6 \text{ mm} [0.24''] \leq c < 15 \text{ mm}$ [0.59'']	2.5 / 560	2.8 / 625	n.a.	2.4 / 540	2.5 / 560
Shear, V_{rec} [kN/lb] For edge distance $c \geq 15 \text{ mm} [0.59'']$	2.7 / 605	2.9 / 650	n.a.	2.7 / 605	2.9 / 650
Moment, M_{rec} [Nm/lbft]	6.7 / 5.0		n.a.	6.7 / 5.0	

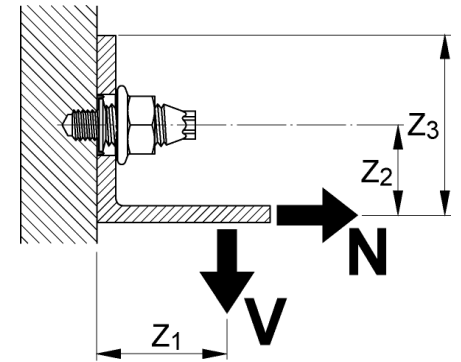
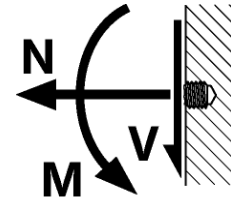

3.2.2 Design loads

S-BT-MR / S-BT-GR made of stainless steel					
Base material thickness	$t_{II} \geq 5 \text{ mm}$ $t_{II} \geq 0.20''$			$3 \text{ mm} \leq t_{II} < 5 \text{ mm}$ $0.12'' \leq t_{II} < 0.20 \text{ mm}$	
Base material type	Steel S235 A36	Steel S355, S420 Grade 50	Aluminum $R_m \geq 270$ N/mm ²	Steel S235 A36	Steel S355, S420 Grade 50
Tension, N_{Rd} [kN/lb]	2.7 / 605	3.2 / 715	2.7 / 605	2.5 / 560	3.0 / 670
Shear, V_{Rd} [kN/lb] For edge distance 6 mm [0.24"] $\leq c < 15 \text{ mm}$ [0.59"]	3.5 / 785	3.9 / 875	4.0 / 895	3.4 / 760	3.5 / 785
Shear, V_{Rd} [kN/lb] For edge distance $c \geq 15 \text{ mm}$ [0.59"]	5.6 / 1255	5.6 / 1255	5.0 / 1120	5.3 / 1190	5.3 / 1190
Moment, M_{Rd} [Nm/lbft]	15.6 / 12.0				

S-BT-MF / S-BT-GF made of duplex-coated carbon steel					
Base material thickness	$t_{II} \geq 5 \text{ mm}$ $t_{II} \geq 0.20''$			$3 \text{ mm} \leq t_{II} < 5 \text{ mm}$ $0.12'' \leq t_{II} < 0.20 \text{ mm}$	
Base material type	Steel S235 A36	Steel S355, S420 Grade 50	Aluminum $R_m \geq 270$ N/mm ²	Steel S235 A36	Steel S355, S420 Grade 50
Tension, N_{Rd} [kN/lb]	2.8 / 625	3.3 / 740	n.a.	2.7 / 605	3.2 / 715
Shear, V_{Rd} [kN/lb] For edge distance 6 mm [0.24"] $\leq c < 15 \text{ mm}$ [0.59"]	3.5 / 785	3.9 / 875	n.a.	3.4 / 760	3.5 / 785
Shear, V_{Rd} [kN/lb] For edge distance $c \geq 15 \text{ mm}$ [0.59"]	3.8 / 850	4.0 / 895	n.a.	3.8 / 850	4.0 / 895
Moment, M_{Rd} [Nm/lbft]	9.4 / 7.0		n.a.	9.4 / 7.0	

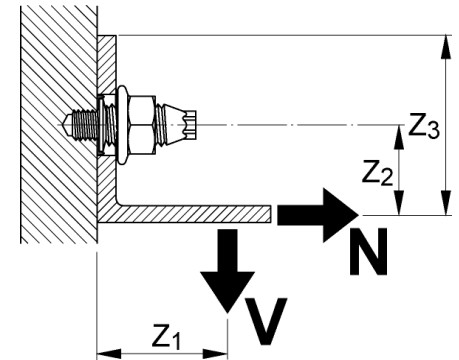
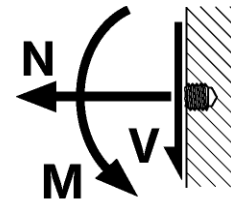
Conditions for recommended loads and design loads:

- Use S-BT-MR and S-BT-MF (multipurpose fastening) only with the attached Hilti serrated flange nuts M8, M10, W10 (⊙ or ⊗ refer to section 3.1.1)
- The design resistance can be used for the design according the partial safety concept, e.g. EN 1993-1-1 (Eurocode 3).
- Global factor of safety Ω resp. partial factor of safety γ_m (based on 5% fractile ultimate test value)

	Recommended loads	Design loads
static pull-out	2.80	2.00
static shear	2.80	2.00
Bending	1.75	1.25
- Minimum edge distance = 6 mm [0.24"], spacing $\geq 18 \text{ mm}$ [0.709"]
- Effect of base metal vibration and stress (e.g. areas with tensile stress) considered.
- Redundancy (multiple fastening) must be provided.
- If eccentric loading exists (e.g. use of an angle clip), moments caused by off-center loading must be considered.

Cyclic loading:

S-BT threaded studs are only to be used for fastenings subject to static or quasi-static loading.

Inquire at Hilti for test data if cyclic loading has to be considered in the design.

3.2.3 Recommended loads S-BT with Hilti standoff adapter

	S-BT-MR / S-BT-MR MT / S-BT-GR with standoff adapter made of stainless steel			
Base material thickness	$t_{II} \geq 5 \text{ mm [0.20"]}$		$t_{II} = 4 \text{ mm [0.16"]}$	$t_{II} = 3 \text{ mm [0.12"]}$
Base material type	Steel S235 A36	Steel S355, S420 Grade 50	Steel¹⁾ S235 A36	Steel¹⁾ S235 A36
Tension, N_{rec} [kN/lb] Standoff Adapter 25, 50, 75, 100 mm	1.89 / 425	2.27 / 510	1.79 / 400	1.79 / 400
Shear, V_{rec} [kN/lb] Standoff Adapter 25 mm	0.84 / 190	1.00 / 225	0.69 / 155	0.55 / 125
Shear, V_{rec} [kN/lb] Standoff Adapter 50 mm	0.45 / 100	0.54 / 120	0.38 / 85	0.31 / 70
Shear, V_{rec} [kN/lb] Standoff Adapter 75 mm	0.33 / 75	0.40 / 90	0.28 / 60	0.24 / 55
Shear, V_{rec} [kN/lb] Standoff Adapter 100 mm	0.23 / 50	0.28 / 60	0.19 / 40	0.18 / 40

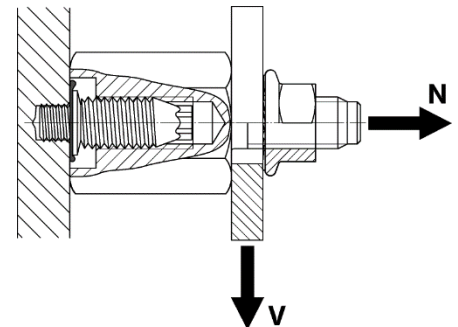

	S-BT-MF / S-BT-MF MT / S-BT-GF with standoff adapter made of duplex coated carbon steel			
Base material thickness	$t_{II} \geq 5 \text{ mm [0.20"]}$		$t_{II} = 4 \text{ mm [0.16"]}$	$t_{II} = 3 \text{ mm [0.12"]}$
Base material type	Steel S235 A36	Steel S355, S420 Grade 50	Steel¹⁾ S235 A36	Steel¹⁾ S235 A36
Tension, N_{rec} [kN/lb] Standoff Adapter 25, 50, 75, 100 mm	1.96 / 440	2.36 / 530	1.89 / 425	1.89 / 425
Shear, V_{rec} [kN/lb] Standoff Adapter 25 mm	0.84 / 190	1.00 / 225	0.69 / 155	0.55 / 125
Shear, V_{rec} [kN/lb] Standoff Adapter 50 mm	0.45 / 100	0.54 / 120	0.38 / 85	0.31 / 70
Shear, V_{rec} [kN/lb] Standoff Adapter 75 mm	0.33 / 75	0.40 / 90	0.28 / 60	0.24 / 55
Shear, V_{rec} [kN/lb] Standoff Adapter 100 mm	0.23 / 50	0.28 / 60	0.19 / 40	0.18 / 40

¹⁾ For steel base material of grade S355, S420, S390GD, S420GD, AH36, DH36, EH36 the values are allowed to be increased up to 20%

3.2.4 Design loads S-BT with Hilti standoff adapter

	S-BT-MR / S-BT-MR MT / S-BT-GR with standoff adapter made of stainless steel			
Base material thickness	$t_{II} \geq 5 \text{ mm [0.20"]}$		$t_{II} = 4 \text{ mm [0.16"]}$	$t_{II} = 3 \text{ mm [0.12"]}$
Base material type	Steel S235 A36	Steel S355, S420 Grade 50	Steel¹⁾ S235 A36	Steel¹⁾ S235 A36
Tension, N_{Rd} [kN/lb] Standoff Adapter 25, 50, 75, 100 mm	2.65 / 595	3.18 / 715	2.50 / 560	2.50 / 560
Shear, V_{Rd} [kN/lb] Standoff Adapter 25 mm	1.17 / 260	1.41 / 315	0.96 / 215	0.77 / 170
Shear, V_{Rd} [kN/lb] Standoff Adapter 50 mm	0.64 / 140	0.76 / 170	0.53 / 120	0.43 / 95
Shear, V_{Rd} [kN/lb] Standoff Adapter 75 mm	0.47 / 105	0.55 / 125	0.39 / 90	0.34 / 75
Shear, V_{Rd} [kN/lb] Standoff Adapter 100 mm	0.32 / 70	0.39 / 90	0.27 / 60	0.25 / 55

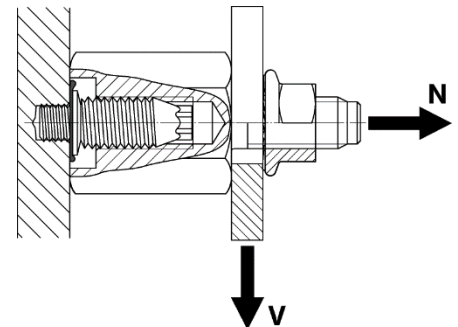

	S-BT-MF / S-BT-MF MT / S-BT-GF with standoff adapter made of duplex coated carbon steel			
Base material thickness	$t_{II} \geq 5 \text{ mm [0.20"]}$		$t_{II} = 4 \text{ mm [0.16"]}$	$t_{II} = 3 \text{ mm [0.12"]}$
Base material type	Steel S235 A36	Steel S355, S420 Grade 50	Steel¹⁾ S235 A36	Steel¹⁾ S235 A36
Tension, N_{Rd} [kN/lb] Standoff Adapter 25, 50, 75, 100 mm	2.75 / 615	3.30 / 740	2.65 / 595	2.65 / 595
Shear, V_{Rd} [kN/lb] Standoff Adapter 25 mm	1.17 / 260	1.41 / 315	0.96 / 215	0.77 / 170
Shear, V_{Rd} [kN/lb] Standoff Adapter 50 mm	0.64 / 140	0.76 / 170	0.53 / 120	0.43 / 95
Shear, V_{Rd} [kN/lb] Standoff Adapter 75 mm	0.47 / 105	0.55 / 125	0.39 / 90	0.34 / 75
Shear, V_{Rd} [kN/lb] Standoff Adapter 100 mm	0.32 / 70	0.39 / 90	0.27 / 60	0.25 / 55

¹⁾ For steel base material of grade S355, S420, S390GD, S420GD, AH36, DH36, EH36 the values are allowed to be increased up to 20%

Conditions for recommended loads and design loads:

- The design resistance can be used for the design according the partial safety concept, e.g. EN 1993-1-1 (Eurocode 3).
- Global factor of safety Ω resp. partial factor of safety γ_m (based on 5% fractile ultimate test value)

	Recommended loads	Design loads
static pull-out	2.80	2.00
static shear	2.80	2.00
- Minimum edge distance = 15 mm [0.59"], spacing $\geq 18 \text{ mm [0.709"]}$
- Effect of base metal vibration and stress (e.g. areas with tensile stress) considered.
- Redundancy (multiple fastening) must be provided.
- Maximum displacement in direction of the shear force $\leq 2.0 \text{ mm [0.08"]}$

3.2.5 Recommended loads S-BT with Hilti coupler RC-MF and RC-MR

S-BT-MR / S-BT-MR MT with coupler RC-MR 47/35 made of stainless steel				
Base material thickness	$t_{II} \geq 5 \text{ mm [0.20"]}$		$t_{II} = 4 \text{ mm [0.16"]}$	$t_{II} = 3 \text{ mm [0.12"]}$
Base material type	Steel¹⁾ S235 A36	Aluminum $R_m \geq 270 \text{ N/mm}^2$	Steel¹⁾ S235 A36	Steel¹⁾ S235 A36
Tension, N_{rec} [kN/lb]	1.89 / 425	1.89 / 425	1.79 / 400	1.79 / 400
Shear, V_{rec} [kN/lb] For edge distance $c \geq 15 \text{ mm [0.59"]}$	0.34 / 75	0.29 / 65	0.34 / 75	0.29 / 65

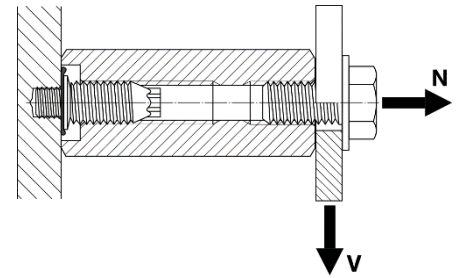

S-BT-MF / S-BT-MF MT with coupler RC-MF 47/35 made of duplex-coated carbon steel				
Base material thickness	$t_{II} \geq 5 \text{ mm [0.20"]}$		$t_{II} = 4 \text{ mm [0.16"]}$	$t_{II} = 3 \text{ mm [0.12"]}$
Base material type	Steel¹⁾ S235 A36	Aluminum $R_m \geq 270 \text{ N/mm}^2$	Steel¹⁾ S235 A36	Steel¹⁾ S235 A36
Tension, N_{rec} [kN/lb]	1.96 / 440	n.a.	1.89 / 425	1.89 / 425
Shear, V_{rec} [kN/lb] For edge distance $c \geq 15 \text{ mm [0.59"]}$	0.34 / 75	n.a.	0.34 / 75	0.29 / 65

¹⁾ For steel base material of grade S355, S420, S390GD, S420GD, AH36, DH36, EH36 the values are allowed to be increased up to 20%

3.2.6 Design loads S-BT with Hilti coupler RC-MF and RC-MR

S-BT-MR / S-BT-MR MT with coupler RC-MR 47/35 made of stainless steel				
Base material thickness	$t_{II} \geq 5 \text{ mm [0.20"]}$		$t_{II} = 4 \text{ mm [0.16"]}$	$t_{II} = 3 \text{ mm [0.12"]}$
Base material type	Steel¹⁾ S235 A36	Aluminum $R_m \geq 270 \text{ N/mm}^2$	Steel¹⁾ S235 A36	Steel¹⁾ S235 A36
Tension, N_{Rd} [kN/lb]	2.65 / 595	2.65 / 595	2.50 / 560	2.50 / 560
Shear, V_{Rd} [kN/lb] For edge distance $c \geq 15 \text{ mm [0.59"]}$	0.48 / 105	0.40 / 90	0.48 / 105	0.40 / 90

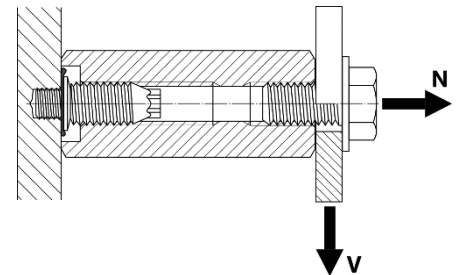

S-BT-MF / S-BT-MF MT with coupler RC-MF 47/35 made of duplex-coated carbon steel				
Base material thickness	$t_{II} \geq 5 \text{ mm [0.20"]}$		$t_{II} = 4 \text{ mm [0.16"]}$	$t_{II} = 3 \text{ mm [0.12"]}$
Base material type	Steel¹⁾ S235 A36	Aluminum $R_m \geq 270 \text{ N/mm}^2$	Steel¹⁾ S235 A36	Steel¹⁾ S235 A36
Tension, N_{Rd} [kN/lb]	2.75 / 615	n.a.	2.65 / 595	2.65 / 595
Shear, V_{Rd} [kN/lb] For edge distance $c \geq 15 \text{ mm [0.59"]}$	0.48 / 105	n.a.	0.48 / 105	0.40 / 90

¹⁾ For steel base material of grade S355, S420, S390GD, S420GD, AH36, DH36, EH36 the values are allowed to be increased up to 20%

Conditions for recommended loads and design loads:

- The design resistance can be used for the design according the partial safety concept, e.g. EN 1993-1-1 (Eurocode 3).
 - Global factor of safety Ω resp. partial factor of safety γ_m (based on 5% fractile ultimate test value)
- | | Recommended loads | Design loads |
|-----------------|-------------------|--------------|
| static pull-out | 2.80 | 2.00 |
| static shear | 2.80 | 2.00 |
- Minimum edge distance = 15 mm [0.59"], spacing \geq 18 mm [0.709"]
 - Effect of base metal vibration and stress (e.g. areas with tensile stress) considered.
 - Redundancy (multiple fastening) must be provided.
 - Maximum displacement in direction of the shear force \leq 2.0 mm [0.08"]

3.2.7 Recommended interaction formula for combined loading – steel and aluminum base materials

V-N (shear and tension) $\frac{V}{V_{rec}} + \frac{N}{N_{rec}} \leq 1.0$ with $\frac{V}{V_{rec}} \leq 1.0$ and $\frac{N}{N_{rec}} \leq 1.0$

V-M (shear and bending) $\frac{V}{V_{rec}} + \frac{M}{M_{rec}} \leq 1.0$ with $\frac{V}{V_{rec}} \leq 1.0$ and $\frac{M}{M_{rec}} \leq 1.0$

N-M (tension and bending) $\frac{N}{N_{rec}} + \frac{M}{M_{rec}} \leq 1.0$

V-N-M (shear, tension and bending) $\frac{V}{V_{rec}} + \frac{N}{N_{rec}} + \frac{M}{M_{rec}} \leq 1.0$

3.2.8 Base material thickness t_{II} and type of bore hole

Pilot hole	Drill through hole
<p>Base material thickness steel and aluminum: $t_{II} \geq 6 \text{ mm [0.24"]}$</p>	<p>Base material thickness steel: $3 \text{ mm [0.12"]} \leq t_{II} < 6 \text{ mm [0.24"]}$ aluminum: $5 \text{ mm [0.20"]} \leq t_{II} < 6 \text{ mm [0.24"]}$</p>

Thickness of base material corrosion protection layer $\leq 0.8 \text{ mm [0.0315"]}$.
For thicker coatings, please contact Hilti.

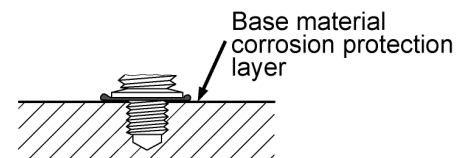

Corrosion information:

The S-BT stainless steel fasteners are made from the duplex stainless steel type 1.4462, which is equivalent to AISI 316 and 318LN steel grade. This grade of stainless steel is classified in the corrosion resistance class IV according to

DIN EN 1993-1-4:2015, which makes the material suitable for aggressive environments like in coastal and offshore applications. The microstructures of duplex stainless steels consist of a mixture of austenite and ferrite phases. Compared to the austenitic stainless steel grades, duplex stainless steels are magnetic. The surface of the S-BT stainless steel fasteners is zinc-coated (anti-friction coating) in order to reduce the thread forming torque when the stud is screwed in into the base material

The coating of the carbon steel S-BT fasteners consists of an electroplated Zn-alloy for cathodic protection and a top coat for chemical resistance (Duplex-coating). The thickness of the coating is 35 µm. This product is designed for use in corrosive categories C1, C2 and C3 according the standard EN ISO 9223. For higher corrosion categories stainless steel fasteners should be used.

In case of a **drill through hole or a pilot hole in thin base material**, rework of the coating on the back side of the plate / profile may be needed.

	S-BT-____AN 6		S-BT-____SN 6	
Corrosivity category C	C3 medium corrosive		C5 very high corrosive	
Drill hole type and base material thickness t_{II} ¹⁾	Topside protection	Backside Protection	Topside protection	Backside Protection
Drill through hole 3 mm [0.12"] ≤ t_{II} < 6 mm [0.24"]	✓	x ²⁾	✓	x ²⁾
Pilot hole, 6 mm [0.24"] ≤ t_{II} < 7 mm [0.28"]	✓	✓	✓	✓ ³⁾
Pilot hole t_{II} ≥ 7 mm [0.28"]	✓	✓	✓	✓

- ¹⁾ Real base material thickness, not nominal material thickness or material thickness with coating.
- ²⁾ Damage of the coating on the back side of the plate / profile require a rework of the coating.
- ³⁾ Damage of the coating on the back side of the plate / profile require a rework of the coating, if the tools SF BT 22-A or SF BT 18-A were used for drilling the bore hole. If the tool SBT 4-A22 was used for drilling the bore hole, no damage of the coating on the back side of the plate / profile will occur.

3.2.9 Thickness of fastened material t_f

- S-BT-____/7_____ 1.6 mm [0.063"] ≤ t_f ≤ 7.0 mm [0.28"]
- S-BT-____/15_____ 1.6 mm [0.063"] ≤ t_f ≤ 15.0 mm [0.59"]

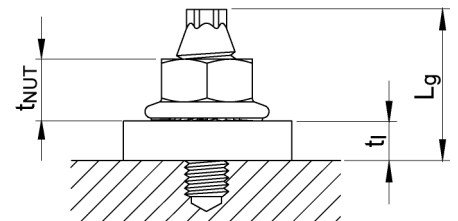

3.2.10 Spacing and edge distances

Edge distance:
 $\geq 6 \text{ mm}$ [0.236"]

Spacing:
 $\geq 18 \text{ mm}$ [0.709"] for all S-BT M8
 $\geq 22 \text{ mm}$ [0.866"] for all S-BT M10 and S-BT W10

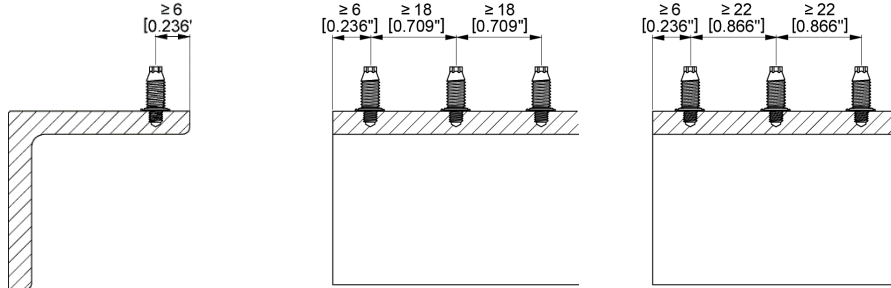

3.2.11 Installation temperature and service temperature

The installation temperature is the temperature at which the S-BT studs are installed. A distinction is made between the temperature of the base material and the temperature of the S-BT studs, drilling and installation tools and accessories. The installation temperature range can be found in the table below.

The service temperature is the temperature at which the S-BT studs operate. The S-BT studs will operate effectively and without any loss in performance (loads, sealing function, etc.) within the specified service temperature range. Outside this temperature range the S-BT studs may fail.

	Installation temperature		Service temperature	
	min	max	min	max
Base material	-40 °C	+60 °C	-40 °C	+100 °C
S-BT studs	-10 °C	+60 °C	-40 °C	+100 °C
Drilling & installation tools and accessories	-10 °C	+60 °C	n.a.	n.a.

Note:

The service temperature range of the connected cable lugs and cables has to be observed. For details please contact the supplier of the cable lugs and cables.

When using Hilti S-BT fasteners in combination with fire rated boundaries in Shipbuilding facilities, the max. service temperature for a period of 60 minutes is higher. For more details refer to section 5.10 "Fire resistance".

3.2.12 Application limit and thickness of base material

The base material is limited to steel grade with a maximum tensile strength $f_u = 630 \text{ MPa}$ [91 ksi].

The minimum tensile strength of steel is $f_u \geq 340 \text{ MPa}$ [49 ksi].

The minimum tensile strength of aluminum is $f_u \geq 270 \text{ MPa}$ [39 ksi].

Minimum thickness of base material t_{II} : refer to section 3.2.8

Maximum thickness of base material t_{II} : no limits

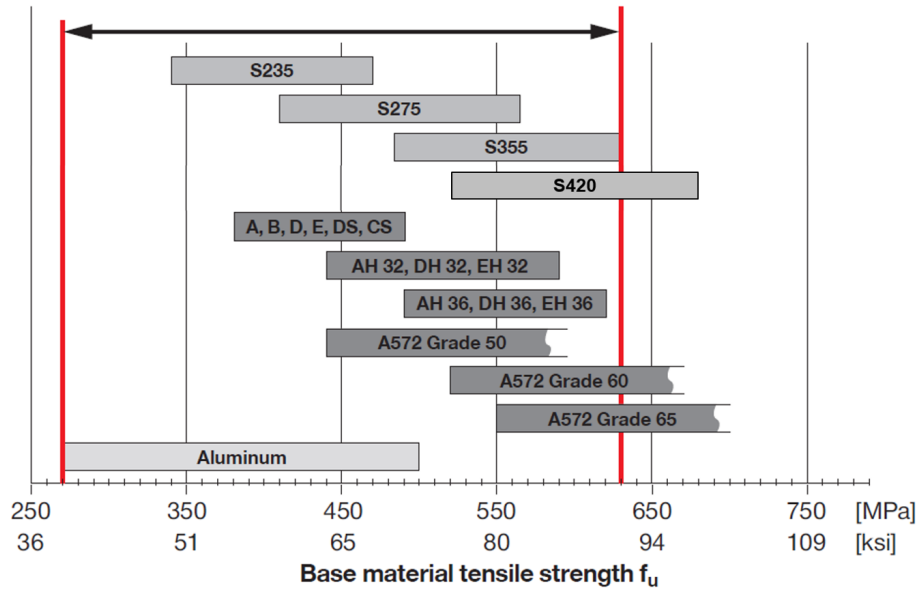

3.2.13 Fastening quality assurance and fastening inspection

Verify stud standoff h_{NVS} with calibration card S-CG BT

S-BT-___/7___6 $h_{NVS} = 18.6 \text{ mm to } 19.1 \text{ mm}$ [0.732" to 0.752"]

S-BT-___/15___6 $h_{NVS} = 29.3 \text{ mm to } 29.8 \text{ mm}$ [1.153" to 1.173"]



Design and functionality of the check gauge S-CG BT

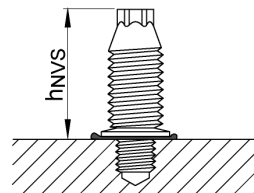

3.2.14 Fastener selection and system recommendation

Fastener	Drilling Tool	Drill bit	Setting Tool	Depth gauge		
Stainless Steel	SF BT 18-A, SF BT 22-A or SBT 4-A22	S-BT-MR M8/7 SN 6	SFC 18-A, SF 4-A22, SFC 22-A or SBT 4-A22	S-DG BT M8/7 Short 6		
		S-BT-MR MT M8/7 SN 6			TS-BT 5.5-74 S	
		S-BT-MR M8/7 SN 6 AL		TS-BT 5.5-74 AL	S-DG BT M8/15 Long 6	
		S-BT-MR M8/15 SN 6		TS-BT 5.5-74 S		
		S-BT-MR M8/15 SN 6 AL		TS-BT 5.5-74 AL	S-DG BT M8/7 Short 6	
		S-BT-ER M8/15 SN 6		TS-BT 5.5-74 S		
		S-BT-GR M8/7 SN 6		TS-BT 5.5-74 S	S-DG BT M8/7 Short 6	
		S-BT-GR M8/7 SN 6 AL		TS-BT 5.5-74 AL		
		S-BT-GR NG M8/7 SN 6		TS-BT 5.5-110 S	S-DG BT M10-W10 Long 6	
		S-BT-MR M10/15 SN 6		TS-BT 5.5-74 S		
		S-BT-MR MT M10/15 SN 6		TS-BT 5.5-74 AL		
		S-BT-MR M10/15 SN 6 AL		TS-BT 5.5-74 S		
		S-BT-MR W10/15 SN 6		TS-BT 5.5-74 AL		
		S-BT-MR W10/15 SN 6 AL		TS-BT 5.5-74 S		
		S-BT-ER M10/15 SN 6		TS-BT 5.5-74 S		
		S-BT-ER W10/15 SN 6		TS-BT 5.5-74 S		
		S-BT-ER M10 HC 120		TS-BT 5.5-74 S TS-BT HC 120/AWG4/0		S-DG BT M10-W10 HC 6
		S-BT-ER W10 HC AWG4/0		TS-BT 5.5-110 S		S-DG BT M8/7 Short 6
Carbon Steel	SF BT 18-A, SF BT 22-A or SBT 4-A22	TS-BT 5.5-74 S	S-DG BT M8/15 Long 6			
				S-BT-GF NG M8/7 AN 6		
			S-BT-GF M8/7 AN 6	S-DG BT M10-W10 Long 6		
			S-BT-MF M8/7 AN 6			
			S-BT-MF MT M8/7 AN 6	S-DG BT M10-W10 Long 6		
			S-BT-MF M8/15 AN 6			
			S-BT-EF M8/15 AN 6	S-DG BT M10-W10 Long 6		
			S-BT-MF M10/15 AN 6			
			S-BT-MF W10/15 AN 6	S-DG BT M10-W10 Long 6		
			S-BT-EF M10/15 AN 6			
			S-BT-EF MT M10/15 AN 6	S-DG BT M10-W10 Long 6		
			S-BT-EF W10/15 AN 6			
			S-BT-EF M10 HC 120	TS-BT 5.5-74 S TS-BT HC 120/AWG4/0	S-DG BT M10-W10 HC 6	
			S-BT-EF W10 HC AWG4/0	TS-BT 5.5-110 S		

Fastener	Standoff adapter	Standoff length	
S-BT-GR M8/7 SN 6	Stainless steel	Adapter M8-MR 25	25 mm [1"]
		Adapter M8-MR 50	50 mm [2"]
		Adapter M8-MR 75	75 mm [3"]
		Adapter M8-MR 100	100 mm [4"]
S-BT-GF M8/7 AN 6	Carbon steel	Adapter M8-MF 25	25 mm [1"]
		Adapter M8-MF 50	50 mm [2"]
		Adapter M8-MF 75	75 mm [3"]
		Adapter M8-MF 100	100 mm [4"]
S-BT-MR MT M10/15 SN 6	Stainless steel	Adapter M10-MR 50	50 mm [2"]
S-BT-MF MT M10/15 AN 6	Carbon steel	Adapter M10-MF 50	50 mm [2"]
S-BT-MR W10/15 SN 6	Stainless steel	Adapter W10-MR 50	50 mm [2"]
S-BT-MF W10/15 AN 6	Carbon steel	Adapter W10-MF 50	50 mm [2"]

3.2.15 Installation details: Fastening S-BT threaded studs with standoff adapter to steel with a passive fire protection (PFP) coating

- ① **Mark location for each fastening**
- ② **Remove PFP and predrill with TS-BT PFP stepped drill bit**
Usage of SBT 4-A22 until the bit shoulder exposes steel and the shoulder grinds a shiny ring to ensure a proper drilling depth. Result is a circle of exposed steel with \varnothing 7.5 mm as well as a maintaining surrounding coating thickness \leq 500 μ m.
- ③ **Screw in the S-BT fastener and check standoff**
Use calibrated depth gauge S-DG BT. Verify stud standoff with the check gauge S-CG BT
- ④ **Screw standoff adapter on the S-BT fastener**
Usage of nutsetter S-NS 3/4" 95/3 3/4" in combination with torque tool X-BT 1/4" – 8 Nm or Hilti screw drivers with correct torque setting
 T_{rec} 8 Nm.
- ⑤ **Repair removed PFP-coating outside of standoff adapter**
Prevent delamination of PFP-coating as well exposure of underlying steel beam by patching area outside of standoff adapter in accordance to the patching instructions by the PFP-manufacturer.
- ⑥ **Position channel or accessory on standoff adapter**
Use bored plate MQZ-L9/11/R as required to increase contact surface and/or center channel on standoff adapter. Tighten nuts by hand.
- ⑦ **Tighten the nuts with recommended torque**
Usage of nutsetter S-NS 3/4" 95/3 3/4" in combination with torque tool X-BT 1/4" – 20 Nm or Hilti screw drivers with correct torque setting
 T_{rec} 20 Nm



Locally exposed steel with shiny ring after PFP-removal operation

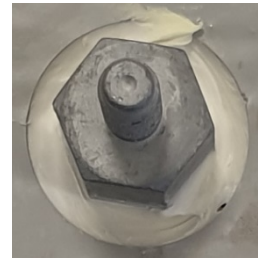

Repaired opening of PFP-coating

	T_{rec}	
	8 Nm	20 Nm
Hilti screw driver:	Torque setting:	
SBT 4-A22	5	11
SF 4-A22	10	n.a.
SFC 18-A	5	11
SFC 22-A	5	11

Important notes:

The setting of the torque via the Hilti screwdriver with torque release coupling (TRC) can change as the clutch wears over time. The specified torque setting is only a rough guide value and applies to a new Hilti screwdriver. Hilti recommends using a calibrated torque wrench or the Hilti Torque tool X-BT 1/4" - 8 Nm to apply the recommended torque.

Exceeding the tightening torque (T_{rec}) leads to damage of the S-BT stud's anchorage with negative impact on the load values and the sealing function.

3.2.16 Installation details
S-BT fastener made of stainless steel with washer-Ø 12mm (S-BT-_R)

 Fastened material hole $\varnothing \geq 13 \text{ mm}$ [0.51"]

S-BT fastener made of carbon steel with washer-Ø 10mm (S-BT-_F)

 Fastened material hole $\varnothing \geq 11 \text{ mm}$ [0.43"]

Remark: for group fastenings subjected to shear loading the fastened material hole diameter should not exceed 14 mm [0.55"] (S-BT-_R) and 12 mm [0.47"] (S-BT-_F) respectively.

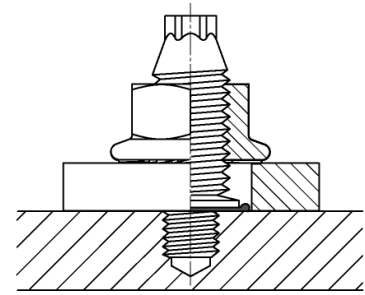
① Mark location for each fastening
② Pre-drill with TS-BT stepped drill bit

Usage of SBT 4-A22, SF BT18-A or SF BT22-A. Pre-drill until the shoulder grinds a shiny ring to assure proper drilling depth.

Before fastener installation:

The drilled hole and the area around the drilled hole must be clear of liquids and debris.

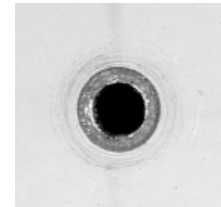

Shiny ring around the bore hole

③ Screw-in S-BT studs into drilled hole

Usage of SBT 4-A22, SF 4-A22, SFC 18-A or SFC 22-A in combination with the calibrated depth gauge S-DG BT.

Verify stud standoff h_{NVS} with check gauge S-CG BT

Sealing washer must be properly compressed!

④ Hang channel or accessory on studs

Tighten nuts by hand

⑤ Tighten the nuts with the suited tightening torque T_{rec}

T_{rec} refer to table below.

Tighten the nuts using

- SBT 4-A22, SF 4-A22, SFC 18-A / 22-A with socket S-NS

- torque tool X-BT 1/4" (8 Nm) or S-BT 1/4" (5 Nm)

- torque wrench

	T_{rec}	
	5 Nm	8 Nm
Hilti screw driver:	Torque setting:	
SBT 4-A22	4	5
SF 4-A22	5	10
SFC 18-A	4	5
SFC 22-A	4	5

Tightening torque serrated flange nut (Multipurpose Fastenings):

	S-BT-_____6				
	Pilot hole, $t_{H1} \geq 6 \text{ mm}$ [0.24"] Drill through hole, 5 mm [0.20"] $\leq t_{H1} < 6 \text{ mm}$ [0.24"]	Steel S235 A36	Steel S355, S420 Grade 50	Aluminum $R_m \geq 270$ N/mm ²	Drill through hole 3mm $\leq t_{H1} < 5 \text{ mm}$ Steel S235 A36
Tightening torque serrated flange nut T_{rec} [Nm/lbft]	8 / 5.9	8 / 5.9	5 / 3.6	5 / 3.6	5 / 3.6

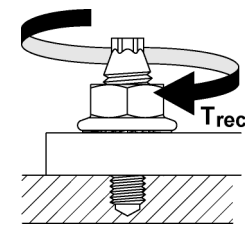
Important notes:

The tightening torque (T_{rec}) for the serrated flange nut is dependent on the stud type, the base material type and thickness, and the drill hole type. Exceeding the tightening torque (T_{rec}) leads to damage of the S-BT stud's anchorage with negative impact on the load values and the sealing function.

Tightening torque S-BT-ER and S-BT-EF (Electrical Connections):

Single point connection type A and double point connection type A

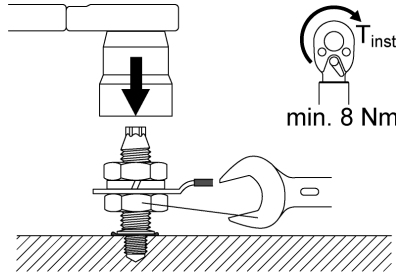

Hold the bottom nut with a spanner while tightening the upper nut.

Tightening Torque: Min. 8 Nm
Max. 20 Nm

Single point connection type B

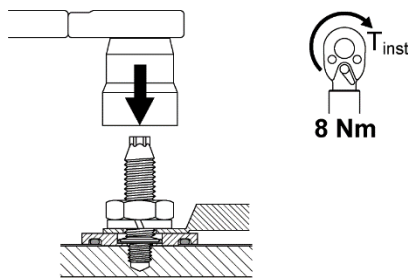

The tightening torque is **8 Nm**. Exceeding or falling below this tightening torque value is not allowed.

Tighten the nut using torque tool X-BT ¼" (8 Nm), torque wrench or Hilti screw driver SBT 4-A22, SFC 18-A, SFC 22-A (torque setting 5) with socket S-NS.

Single point connection with Hilti standoff adapter, Type B

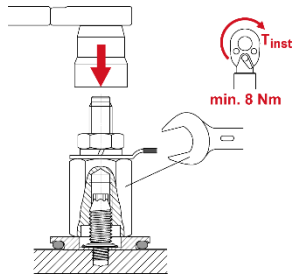

Hold the standoff adapter with a spanner while tightening the **upper nut**.

Tightening Torque: Min. 8 Nm
Max. 20 Nm

The tightening torque of the **standoff adapter** is **8 Nm**.

Exceeding or falling below this tightening torque value is not allowed.

Tighten the nut using torque tool X-BT ¼" (8 Nm), torque wrench or Hilti screw driver SBT 4-A22, SFC 18-A, SFC 22-A (torque setting 5) with socket S-NS

Tightening torque X-FCM, X-FCM NG discs and X-FCS-R grating fastener (Grating Fastening Systems):

Refer to chapter 2.2 and review / follow the instructions for use (IFU) accompanying the product.

Important notes:

The setting of the torque via the Hilti screwdriver with torque release coupling (TRC) can change as the clutch wears over time. The specified torque setting is only a rough guide value and applies to a new Hilti screwdriver. Hilti recommends using a calibrated torque wrench or the Hilti Torque tool S-BT ¼" - 5 Nm or X-BT ¼" - 8 Nm to apply the recommended torque.

These are abbreviated instructions which may vary by application. ALWAYS review / follow the instructions for use (IFU) accompanying the product. In case of a **drill through hole**, rework of the coating on the back side of the plate / profile may be needed.

4 METHOD STATEMENT

4.1 Instruction for use – S-BT-MF M6, M8, M10, W6, W10

S-BT-MF M6/15 AN 6
S-BT-MF W6/15 AN 6
S-BT-MF M8/15 AN 6
S-BT-MF M10/15 AN 6
S-BT-MF W10/15 AN 6

Hex nut with flange M6-F
Hex nut with flange W6-F
Hex nut with flange M8-F
Hex nut with flange M10-F
Hex nut with flange W10-F

	SBT 4-A22 SF BT 18/22-A
	TS-BT 5.5-74 S
	SBT 4-A22 SFC 18/22-A
	S-DG BT M6 - W6 / 15 Long 6 S-DG BT M8 / 15 Long 6 S-DG BT M10 - W10 / 15 Long 6
	S-CC BT 6
	Torque tool X-BT 1/4 8 Nm / 5.9 ft.lb
	S-NS 10 C 95/3 3/4 (M6) S-NS 5/16" C 95/3 3/4 (W6) S-NS 13 C 95/3 3/4 (M8) S-NS 15 C 95/3 3/4 (M10) S-NS 5/16" C 95/3 3/4 (W10)

1

GEAR #2
SBT 4-A22
SF BT 18/22-A

2

3

SBT 4-A22
SFC 18/22-A

3

S-DG BT M6 - W6 / 15 Long 6
S-DG BT M8 / 15 Long 6
S-DG BT M10 - W10 / 15 Long 6

4

5

SBT 4-A22
SFC 18/22-A

GEAR #1

6

7

9a

9b

10

11

12a

8 Nm / 5.9 ft.lb

12b

SBT 4-A22
SFC 18/22-A

12c

$\leq 8 \text{ Nm}$

4.2 Instruction for use – S-BT-MF M8/7 AN 6

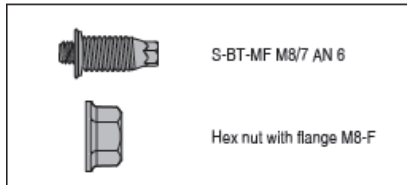
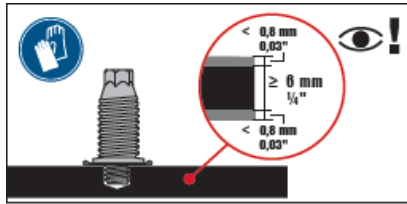

	SBT 4-A22 SF BT 18/22-A
	TS-BT 5.5-74 S
	SBT 4-A22 SFC 18/22-A
	S-DG BT M8/7 Short 6
	S-CC BT 6

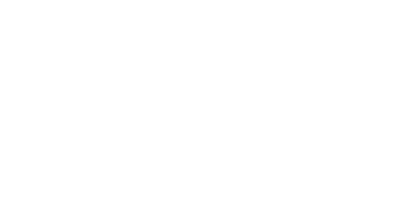
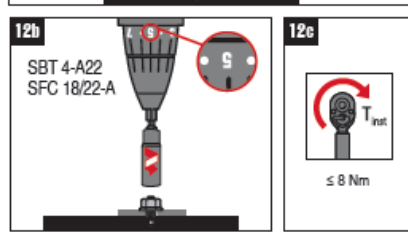
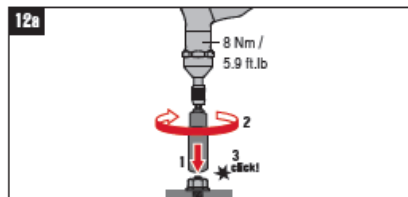
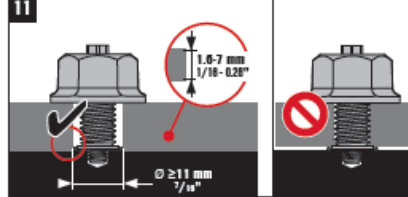
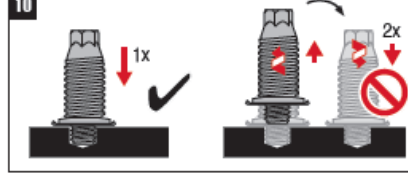
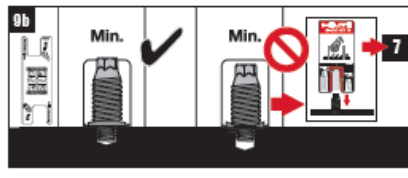
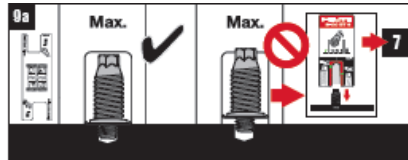
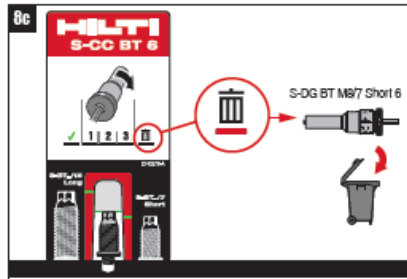
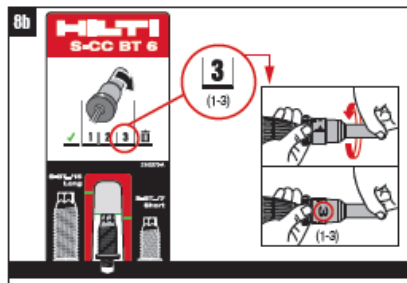
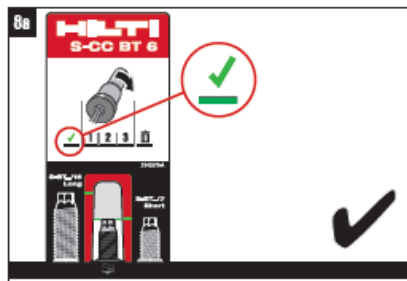
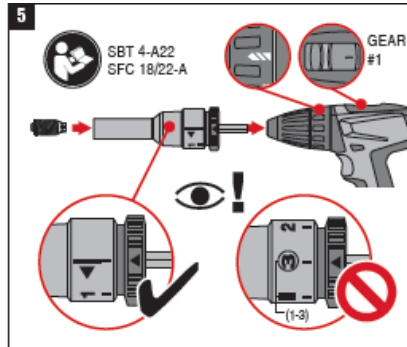
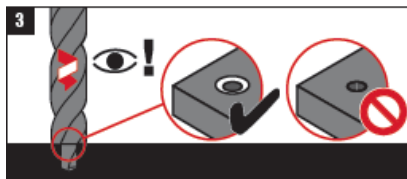
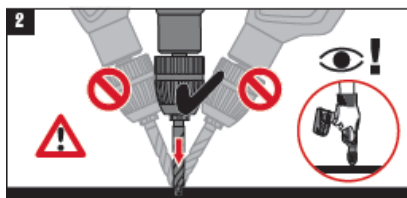
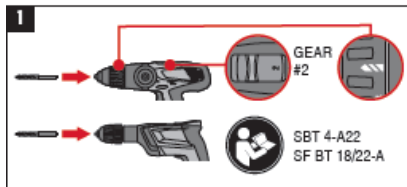
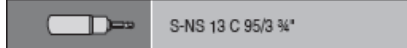

4.3 Instruction for use – S-BT-MR M6, M8, M10, W6, W10 SN 6

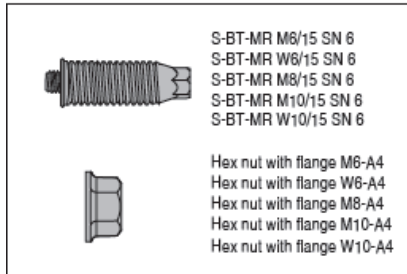
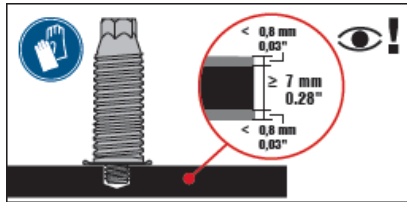

	SBT 4-A22 SF BT 18/22-A
	TS-BT 5.5-74 S
	SBT 4-A22 SFC 18/22-A
	S-DG BT M6 - W6 / 15 Long 6 S-DG BT M8 / 15 Long 6 S-DG BT M10 - W10 / 15 Long 6
	S-CC BT 6

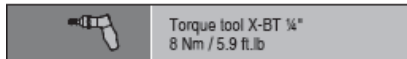

	S-NS 10 C 95/3 3/4 (M6) S-NS 9/16 C 95/3 3/4 (W6)
	S-NS 13 C 95/3 3/4 (M8) S-NS 15 C 95/3 3/4 (M10)
	S-NS 9/16 C 95/3 3/4 (W10)

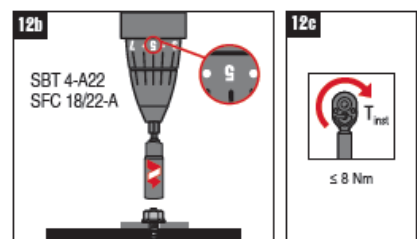
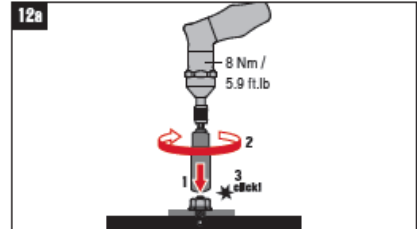
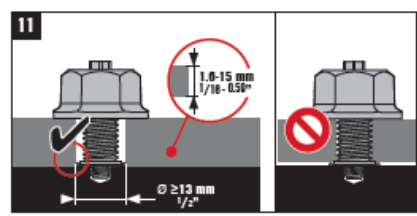
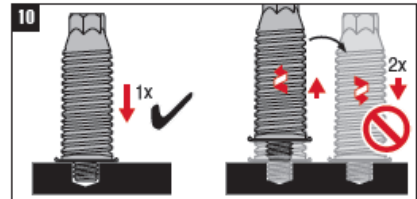
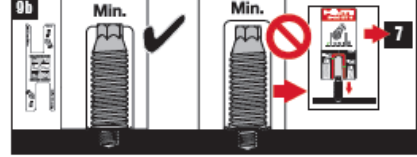
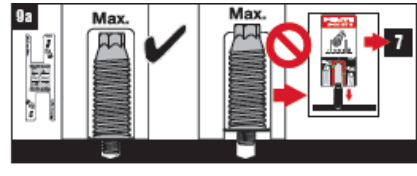
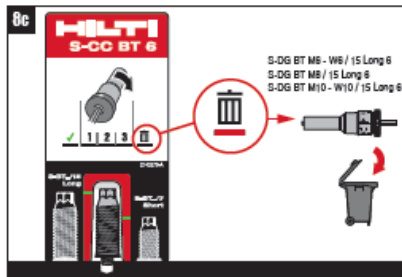
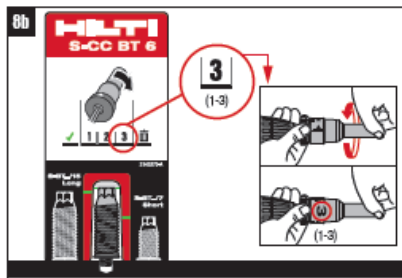
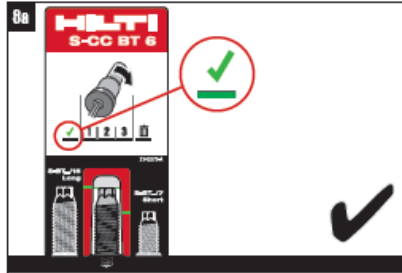
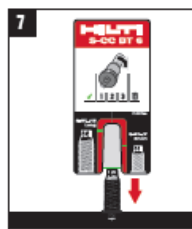
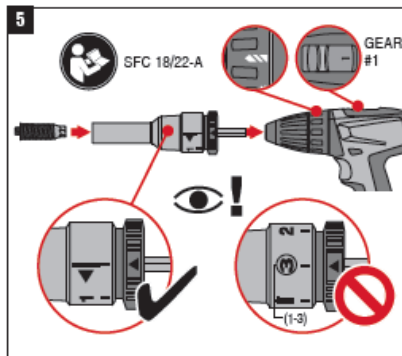
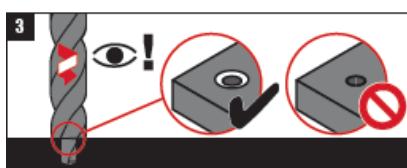
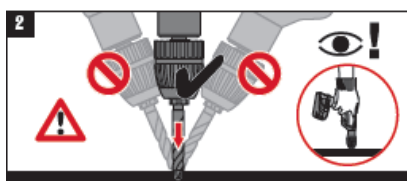
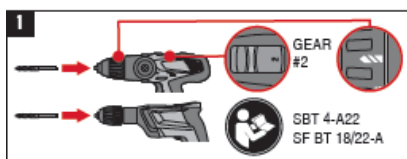

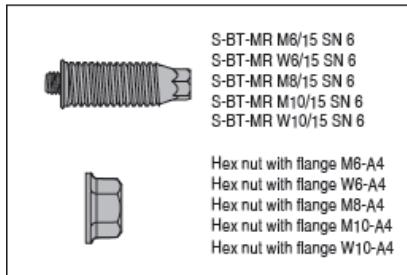
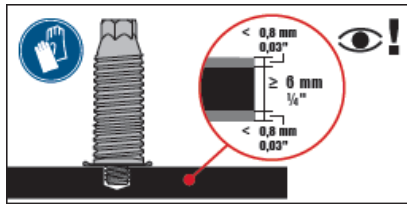

	SBT 4-A22
	TS-BT 5.5-74 S
	SBT 4-A22 SFC 18/22-A
	S-DG BT M6 - W6 / 15 Long 6
	S-DG BT M8 / 15 Long 6
	S-DG BT M10 - W10 / 15 Long 6
	S-CC BT 6

	Torque tool X-BT 1/4" 8 Nm / 5.9 ft.lb
--	---

	S-NS 10 C 95/3 3/4" (M6)
	S-NS 5 1/16" C 95/3 3/4" (W6)
	S-NS 13 C 95/3 3/4" (M8)
	S-NS 15 C 95/3 3/4" (M10)
	S-NS 3 1/16" C 95/3 3/4" (W10)

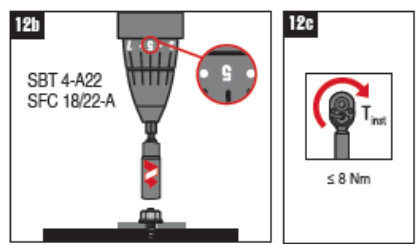
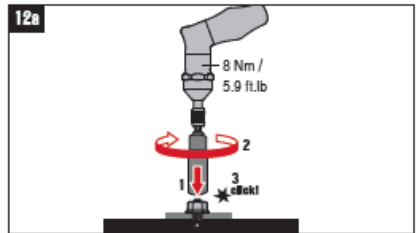
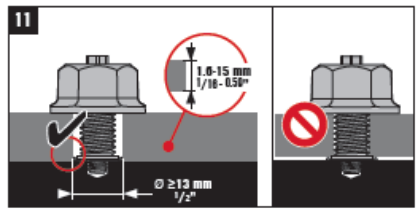
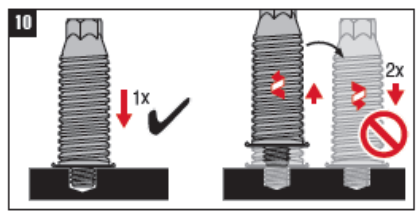
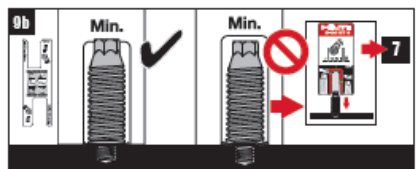
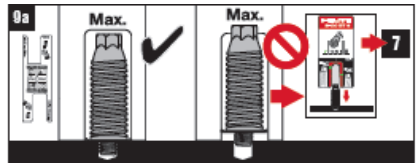
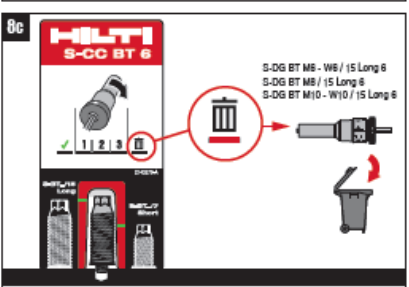
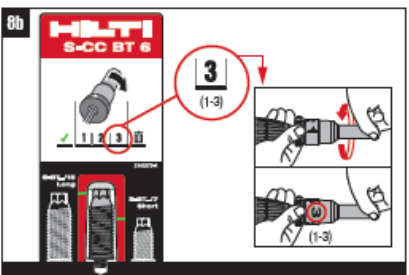
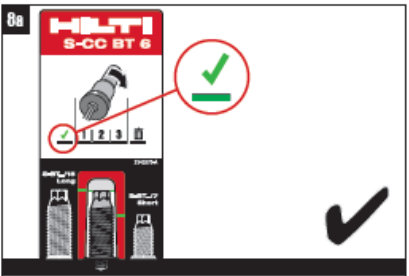
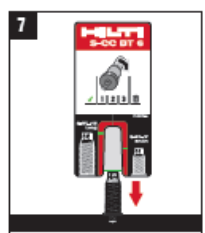
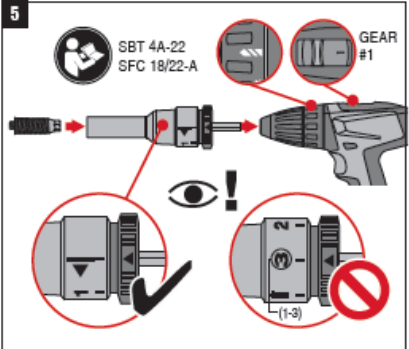
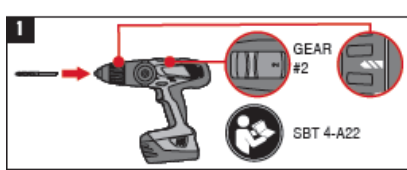

4.4 Instruction for use – S-BT-MR M8/7 SN 6

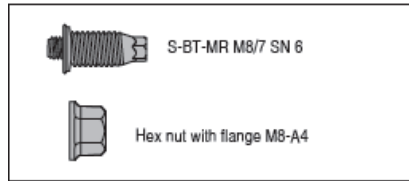
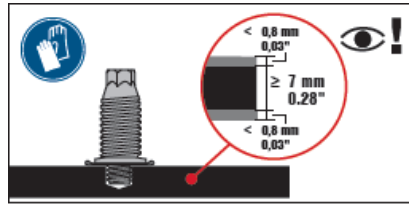

	SBT 4-A22 SF BT 18/22-A
	TS-BT 5.5-74 S
	SBT 4-A22 SFC 18/22-A
	S-DG BT M8/7 Short 6
	S-CC BT 6

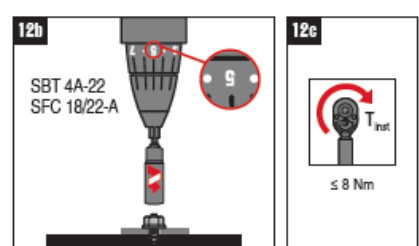
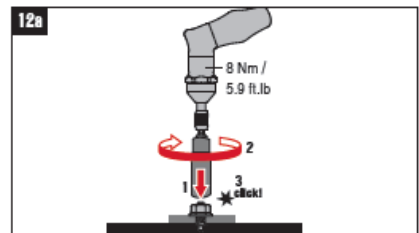
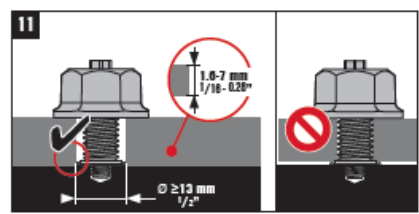
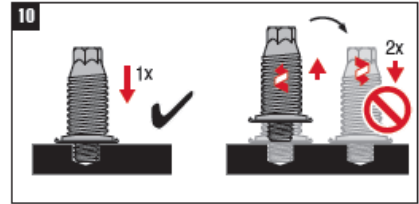
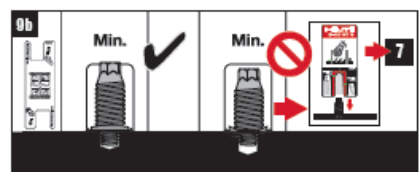
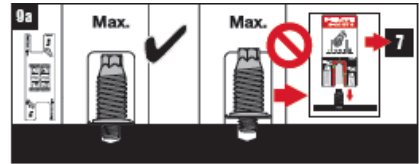
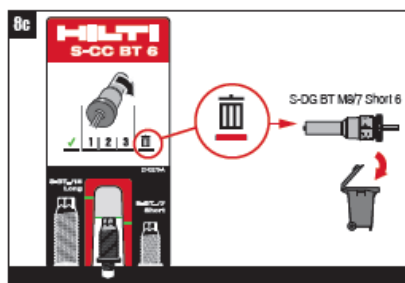
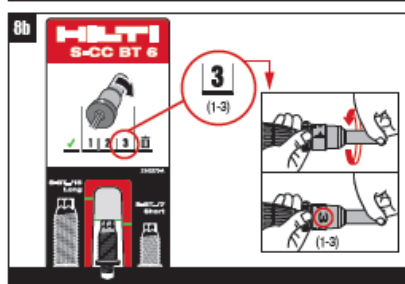
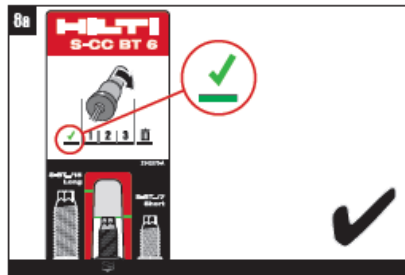
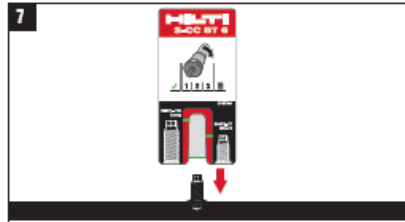
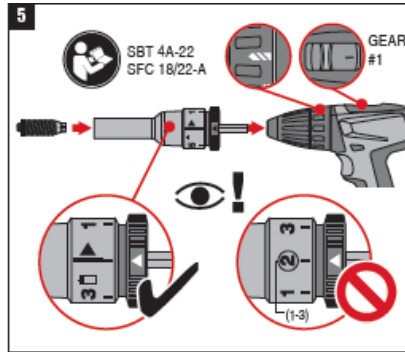
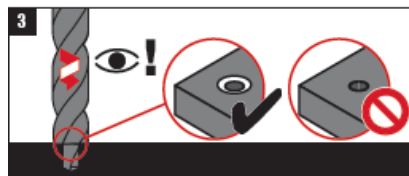
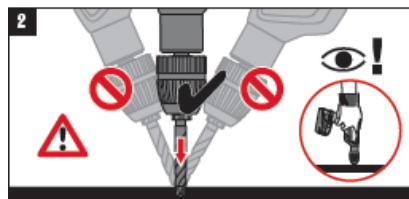
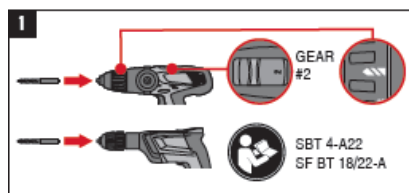
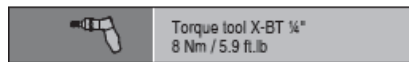

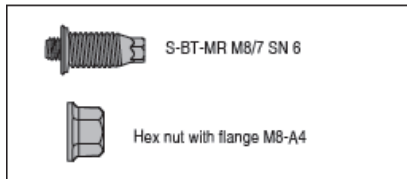
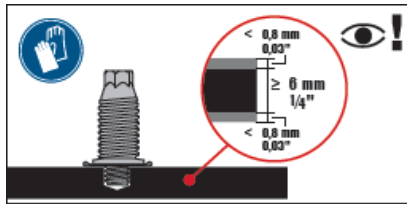

	SBT 4-A22
	TS-BT 5.5-74 S
	SBT 4-A22 SFC 18/22-A
	S-DG BT M8/7 Short 6
	S-CC BT 6

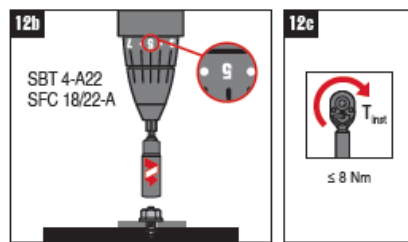
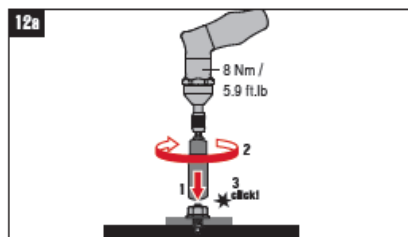
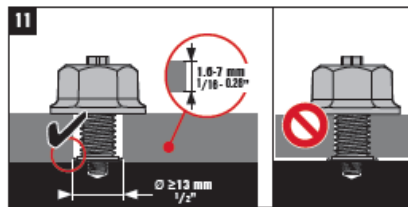
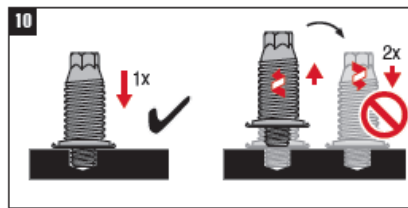
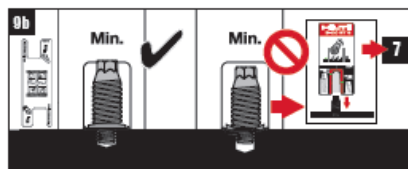
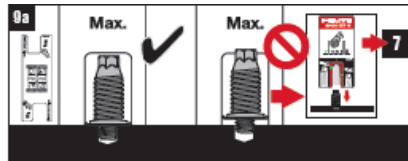
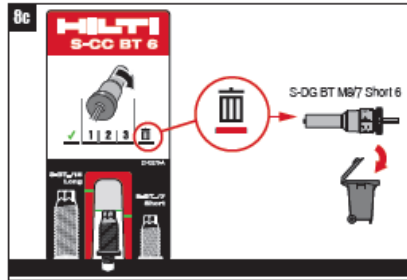
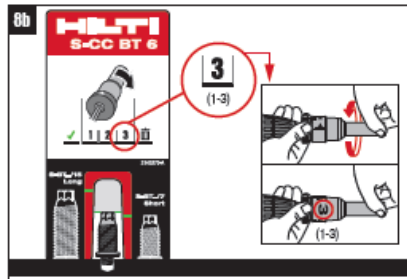
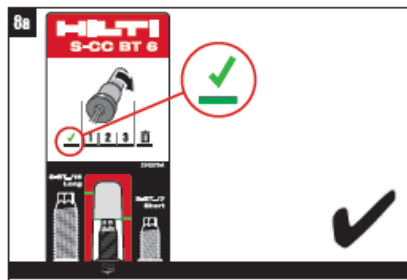
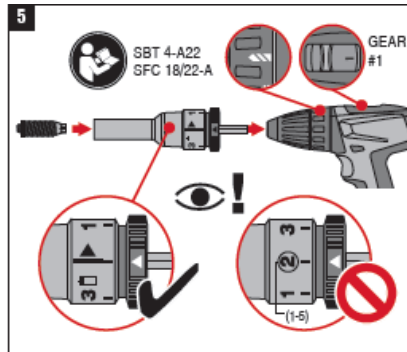
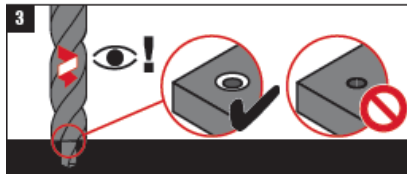
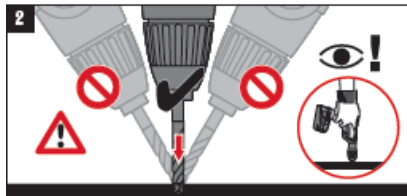
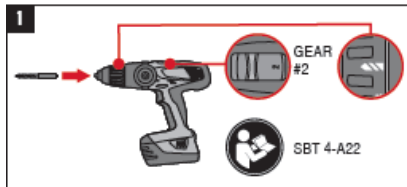

4.5 Instruction for use – S-BT-MR M6, M8, M10, W6, W10 SN 6 AL

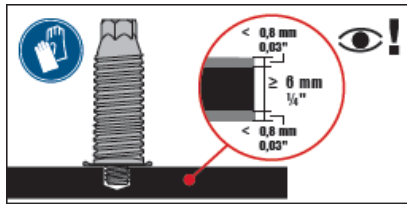

	S-BT-MR M6/15 SN 6
	S-BT-MR W6/15 SN 6
	S-BT-MR M8/15 SN 6
	S-BT-MR M10/15 SN 6
	S-BT-MR W10/15 SN 6
	Hex nut with flange M6-A4
	Hex nut with flange W6-A4
	Hex nut with flange M8-A4
	Hex nut with flange M10-A4
	Hex nut with flange W10-A4

	SBT 4-A22 SF BT 18/22-A
	TS-BT 5.5-74 AL
	SBT 4-A22 SFC 18/22-A
	S-DG BT M6 - W6 / 15 Long 6 S-DG BT M8 / 15 Long 6 S-DG BT M10 - W10 / 15 Long 6
	S-CC BT 6

	Torque tool X-BT 1/4 5 Nm / 3.7 ft.lb
--	--

	S-NS 10 C 95/3 3/4 (M6) S-NS 5/16 C 95/3 3/4 (W6) S-NS 13 C 95/3 3/4 (M8) S-NS 15 C 95/3 3/4 (M10) S-NS 9/16 C 95/3 3/4 (W10)
--	---

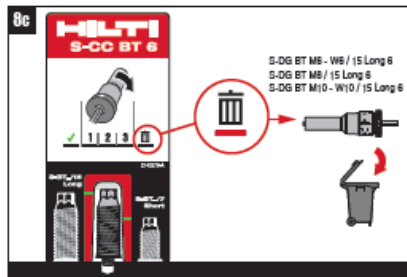
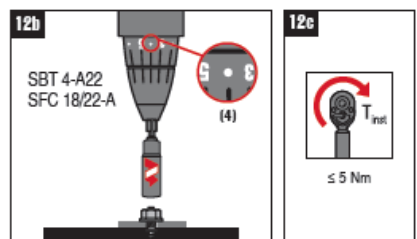
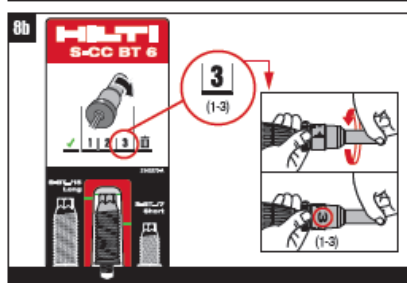
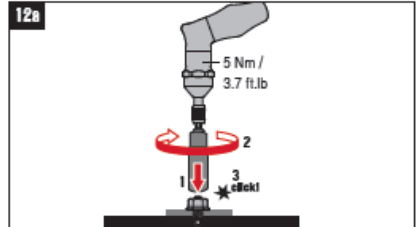
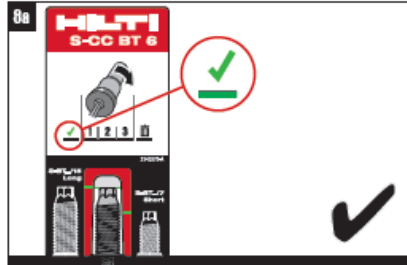
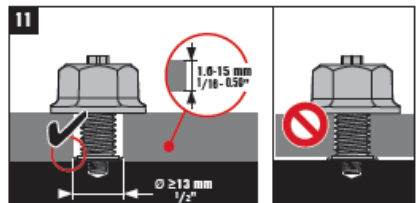
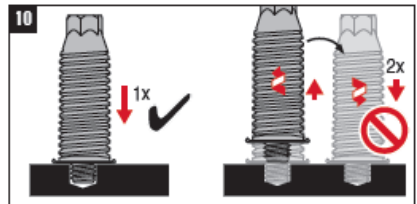
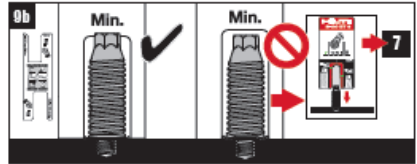
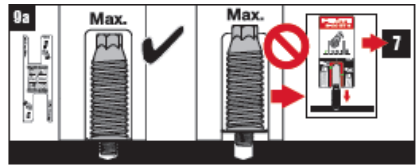
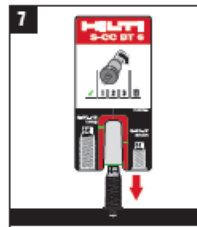
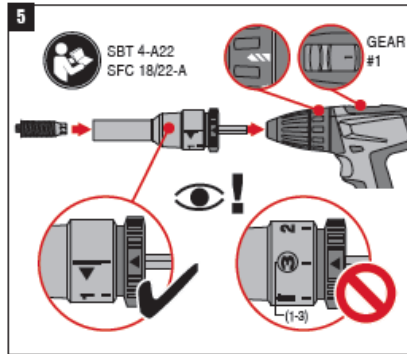
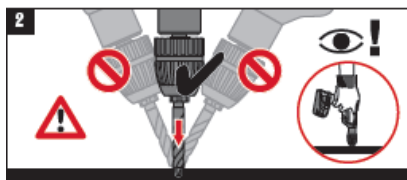
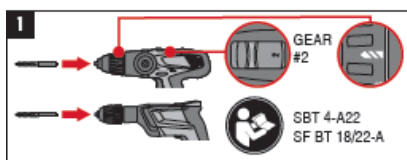

4.6 Instruction for use – S-BT-MR M8/7 SN 6 AL

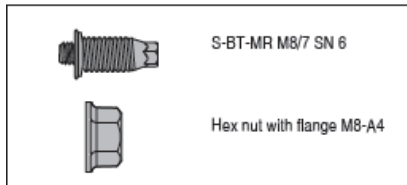
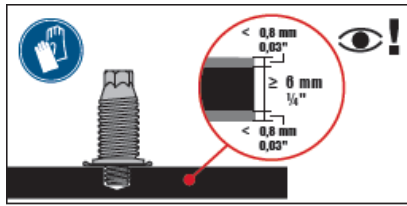

	SBT 4-A22 SF BT 18/22-A
	TS-BT 5.5-74 AL
	SBT 4-A22 SFC 18/22-A
	S-DG BT M8/7 Short 6
	S-CC BT 6

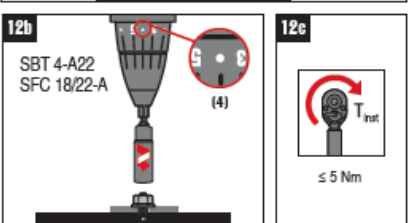
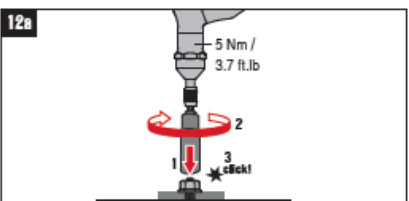
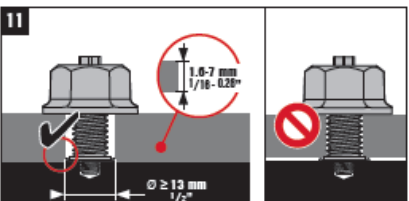
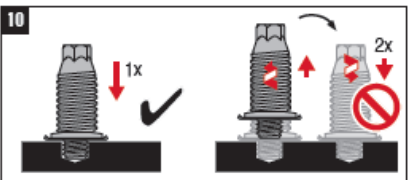
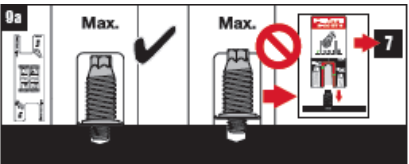
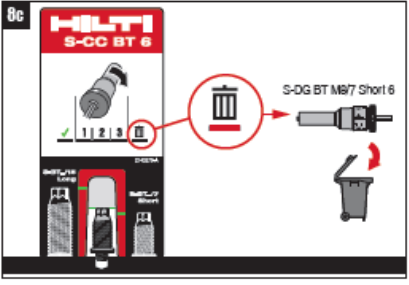
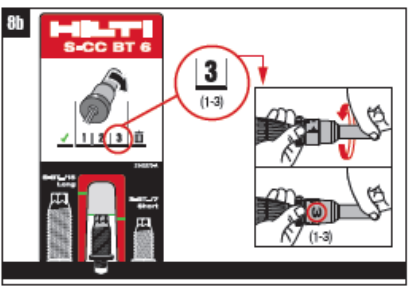
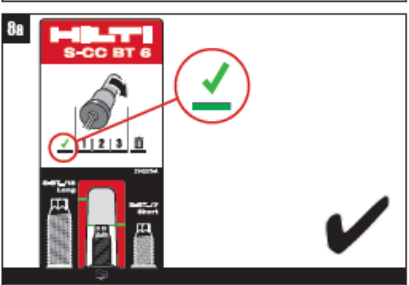
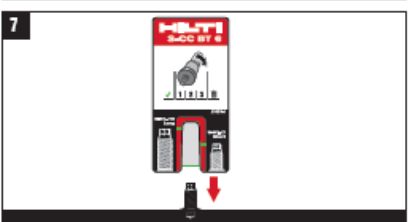
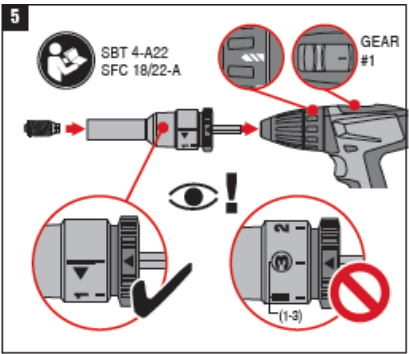
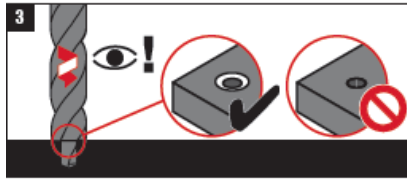
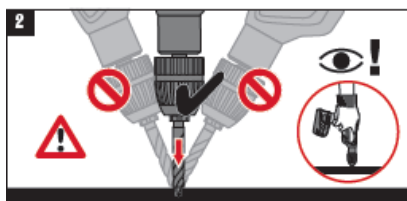
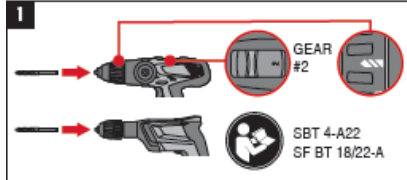
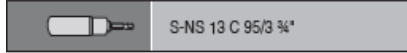
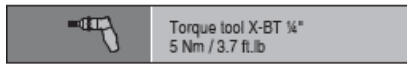

4.7 Instruction for use – S-BT-GF M8/7 AN 6

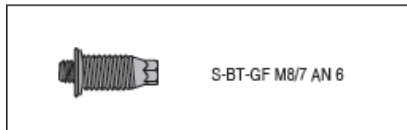
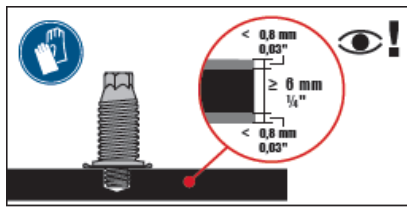

	SBT 4-A22 SF BT 18/22-A
	TS-BT 5.5-74 S
	SBT 4-A22 SFC 18/22-A
	S-DG BT M8/7 Short 6
	S-CC BT 6

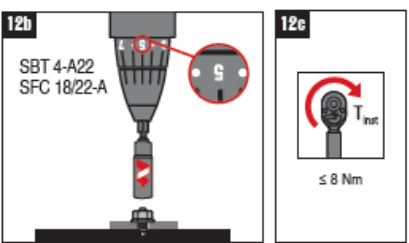
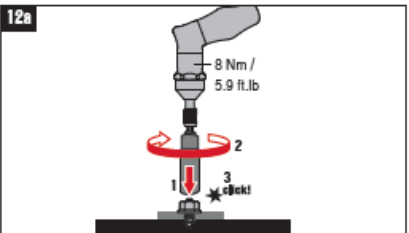
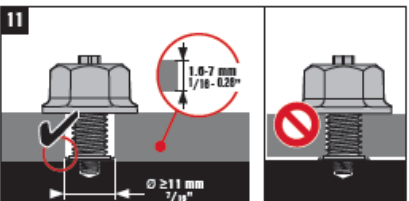
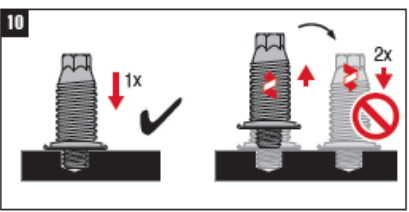
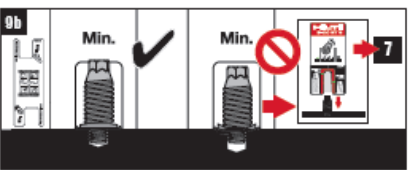
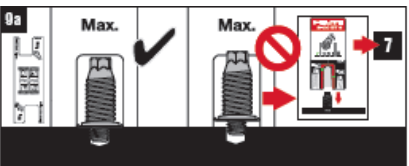
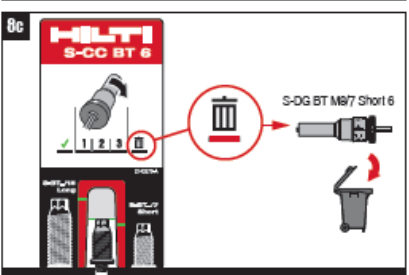
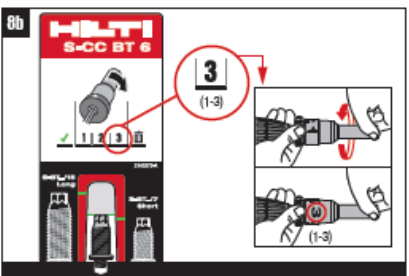
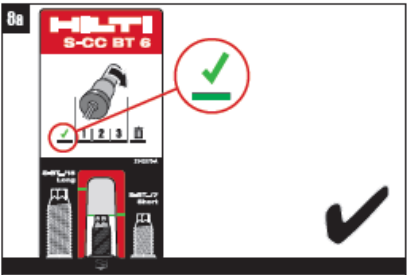
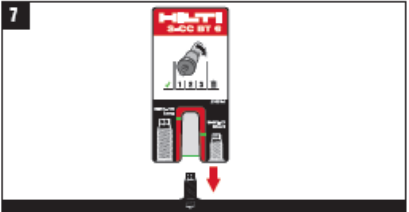
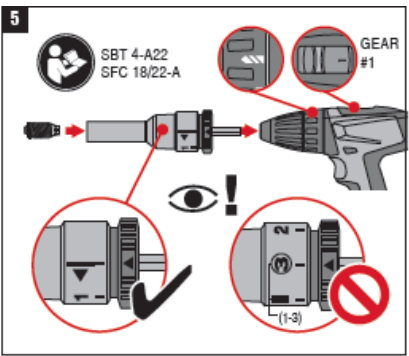
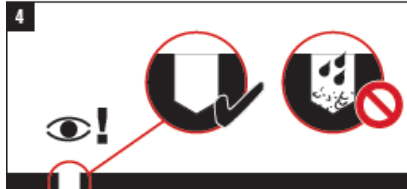
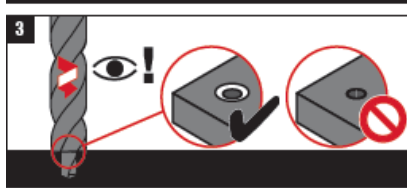
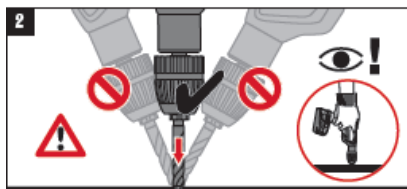
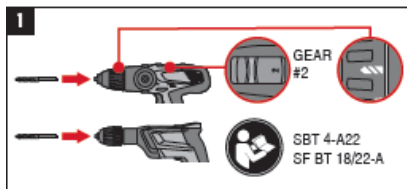
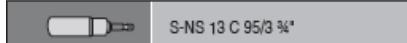

4.8 Instruction for use – S-BT-GR M8/7 SN 6

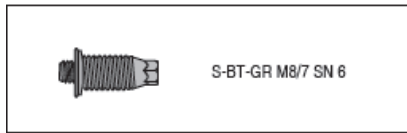
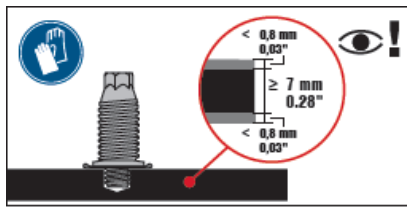

	SBT 4-A22 SF BT 18/22-A
	TS-BT 5.5-74 S
	SBT 4-A22 SFC 18/22-A
	S-DG BT M8/7 Short 6
	S-CC BT 6

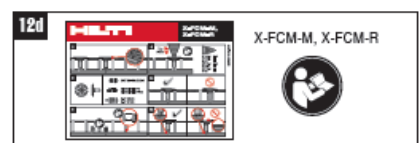
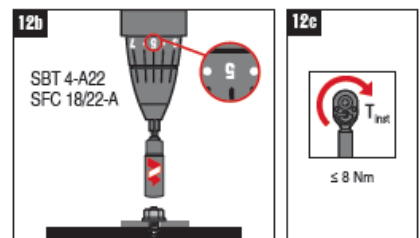
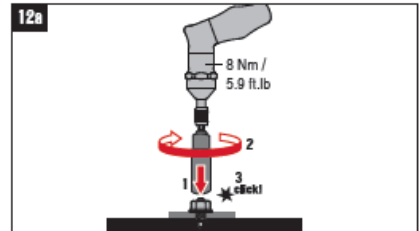
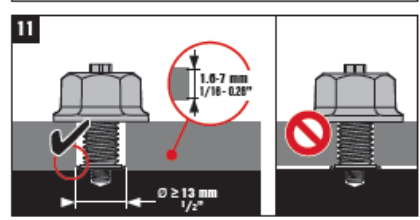
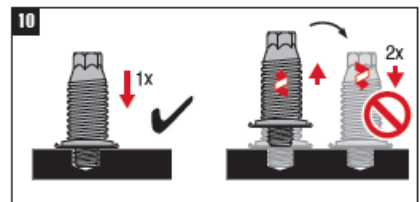
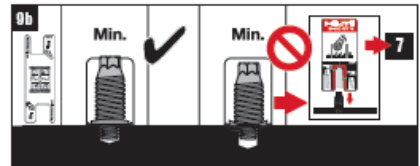
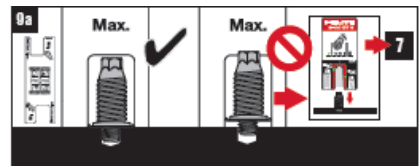
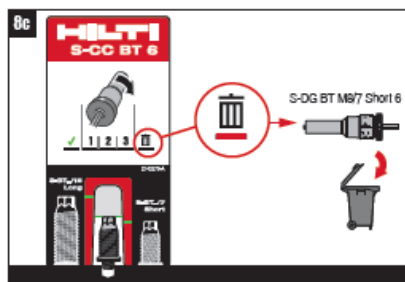
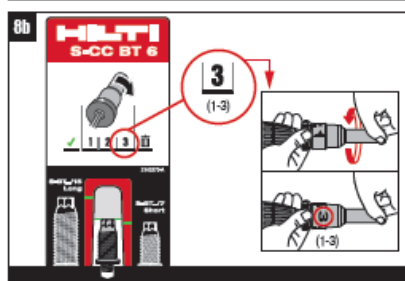
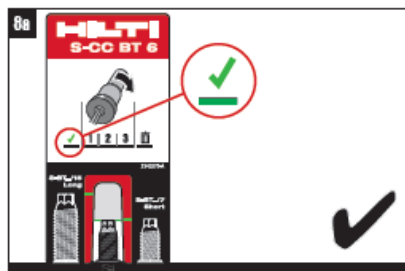
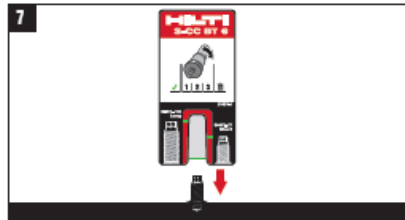
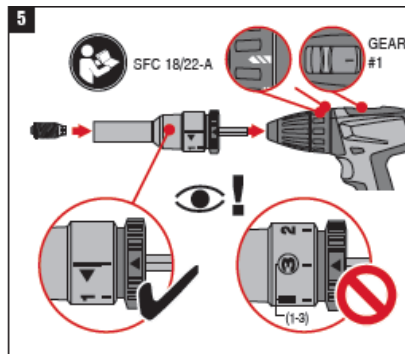
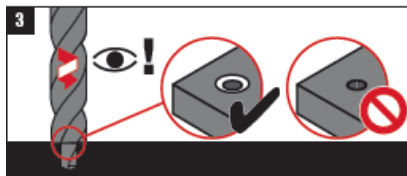
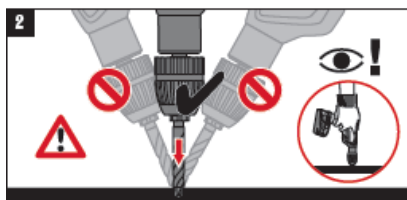
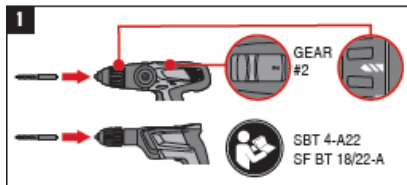
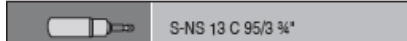

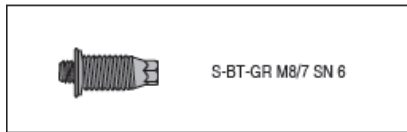
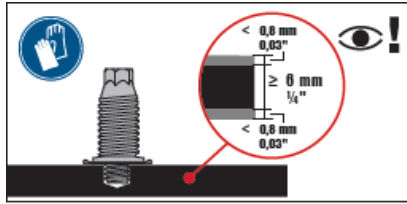

	SBT 4-A22
	TS-BT 5.5-74 S
	SBT 4-A22 SFC 18/22-A
	S-DG BT M8/7 Short 6
	S-CC BT 6

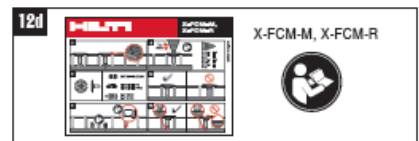
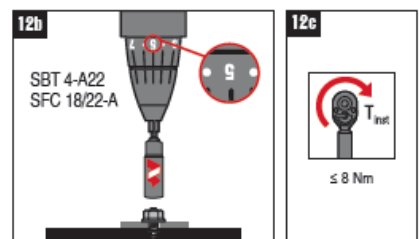
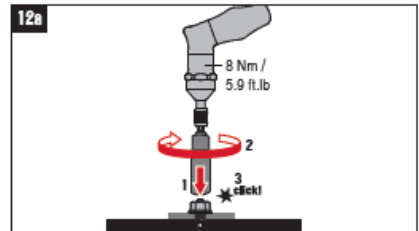
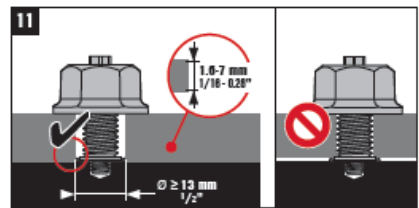
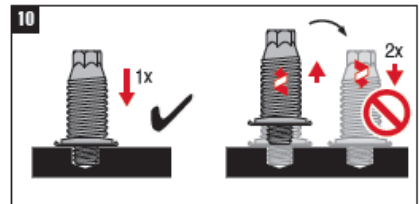
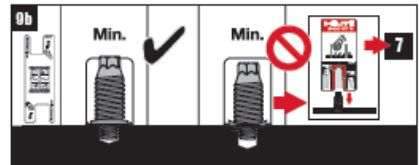
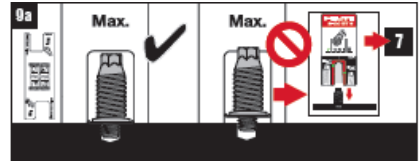
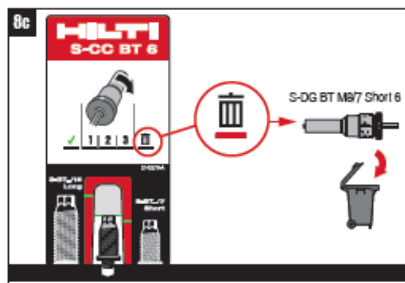
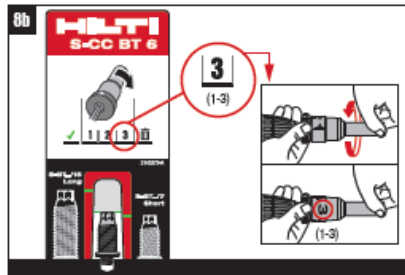
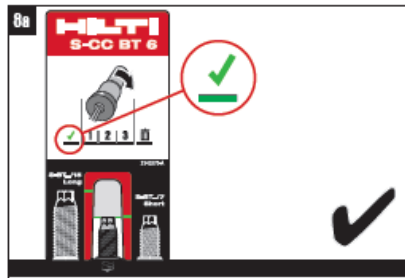
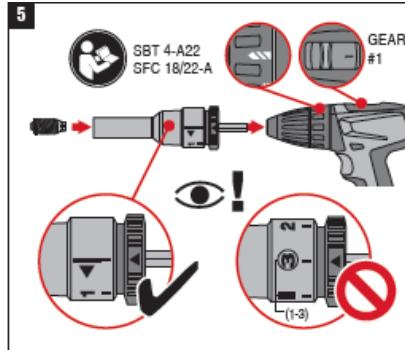
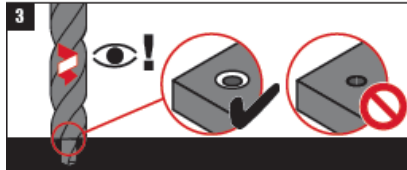
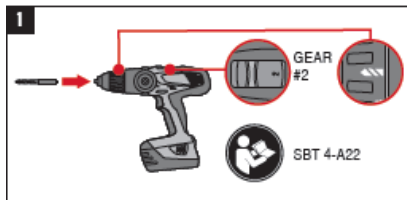
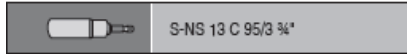
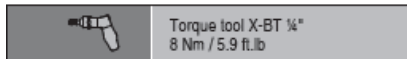

4.9 Instruction for use – S-BT-GR M8/7 SN 6 AL

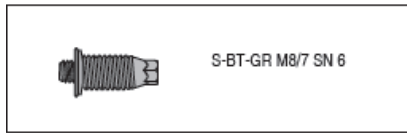
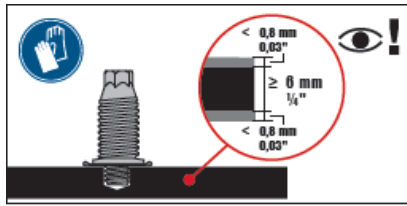

	SBT 4-A22 SF BT 18/22-A
	TS-BT 5.5-74 AL
	SBT 4-A22 SFC 18/22-A
	S-DG BT M8/7 Short 6
	S-CC BT 6

Torque tool X-BT 1/4"
5 Nm / 3.7 ft.lb

S-NS 13 C 95/3 3/4"

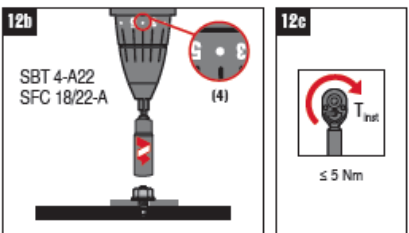
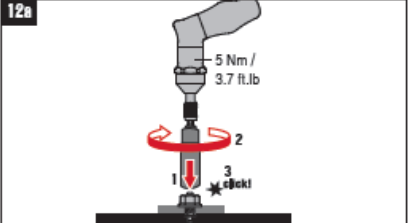
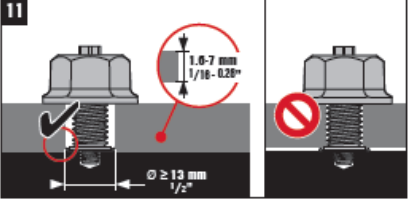
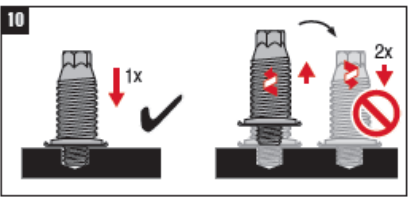
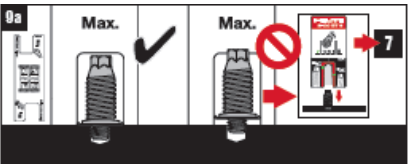
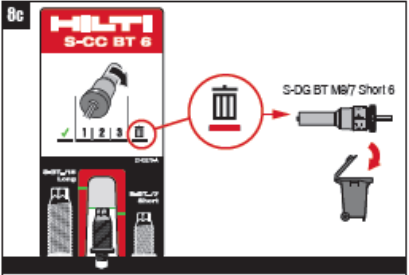
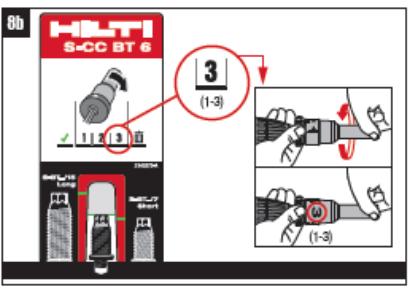
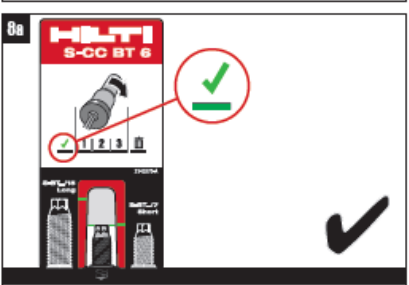
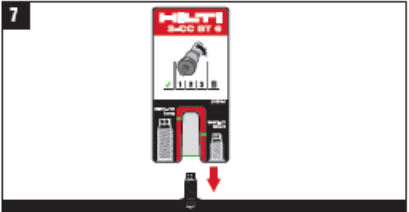
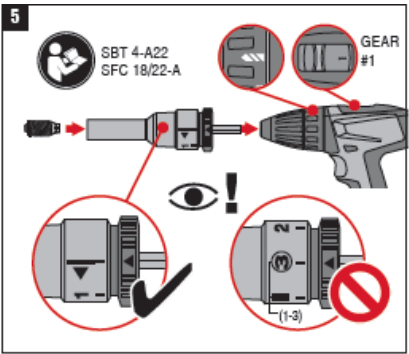
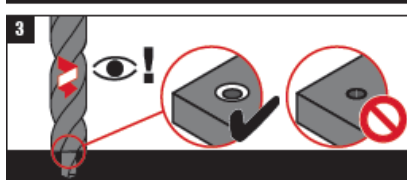
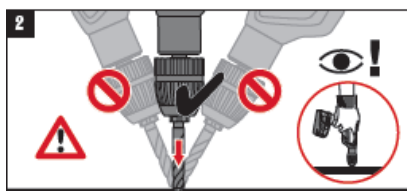
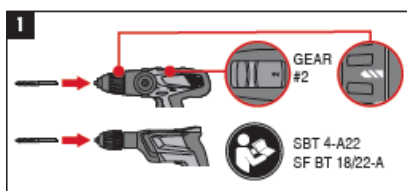

4.10 Instruction for use – S-BT-EF M6/W6/M8

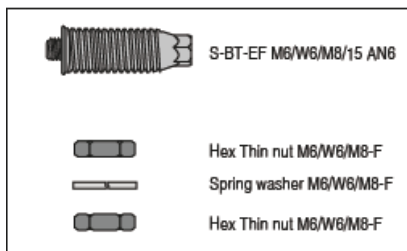
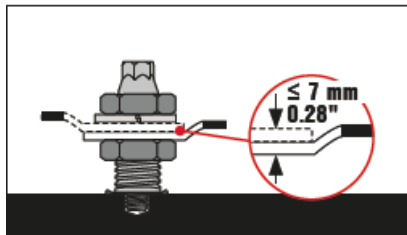
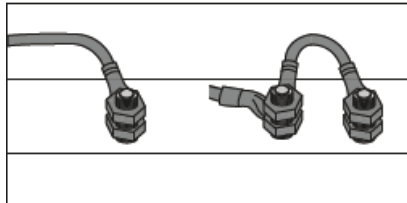
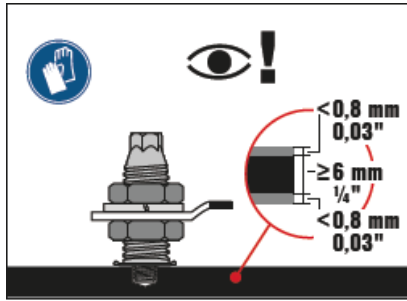

	SBT 4-A22 SF BT 18/22-A
	TS-BT 5.5-74 S
	SBT 4-A22 SFC 18/22-A
	S-DG BT M8/15 Long 6 S-DG BT M6-W6/15 Long 6
	S-CC BT 6

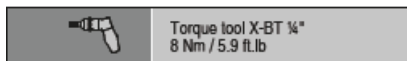

	Torque tool X-BT 1/4 8 Nm / 5.9 ft.lb
	S-NS 10 C 95/3 3/4 (M6) S-NS 5/6 C 95/3 3/4 (W6) S-NS 13 C 95/3 3/4 (M8)

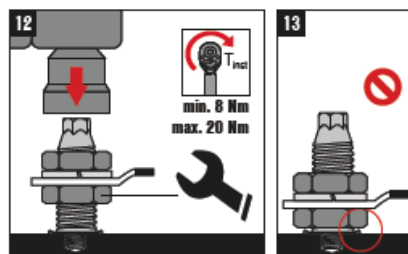
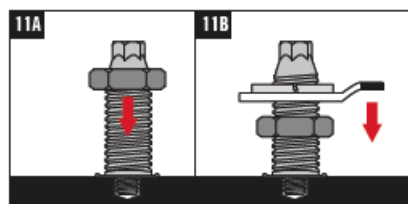
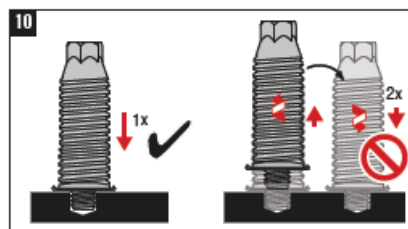
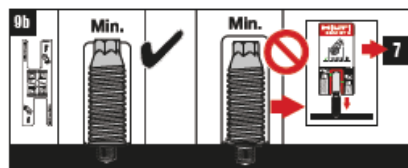
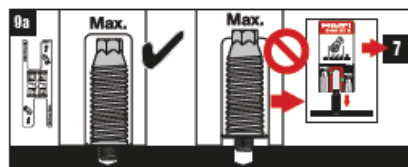
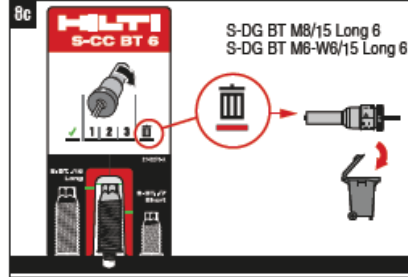
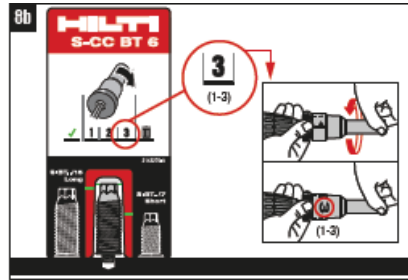
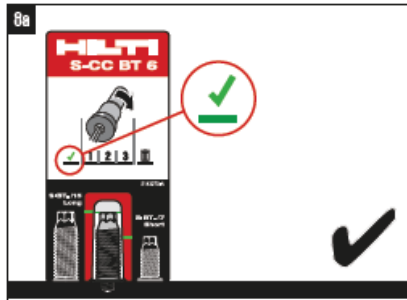
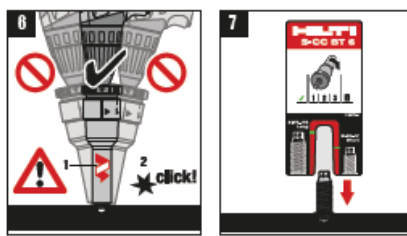
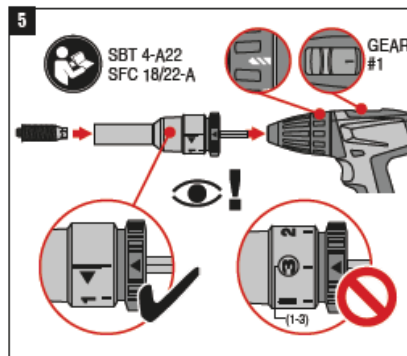
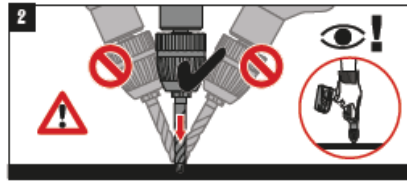
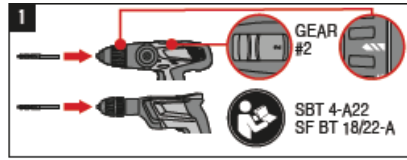

4.11 Instruction for use – S-BT-EF M10/W10

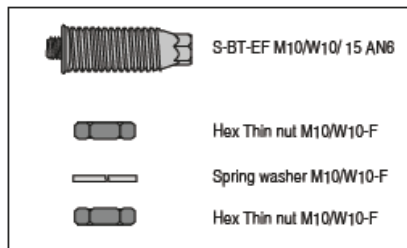
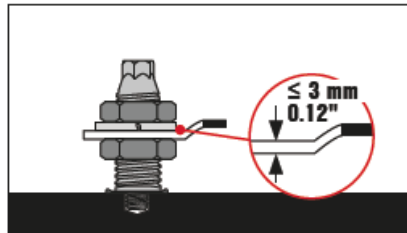
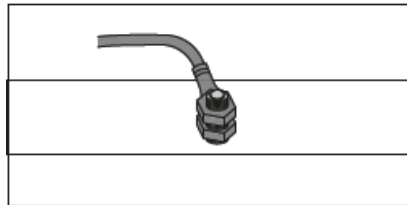
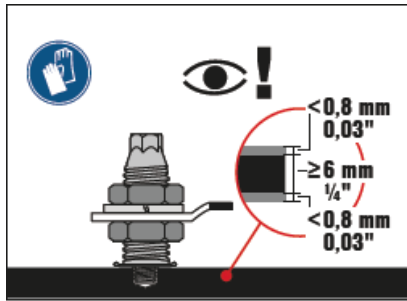

	SBT 4-A22 SF BT 18/22-A
	TS-BT 5.5-74 S
	SBT 4-A22 SFC 18/22-A
	S-DG-BT M10-W10/15 Long 6
	S-CC BT 6

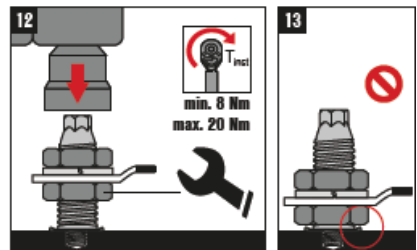
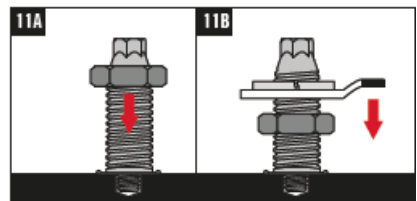
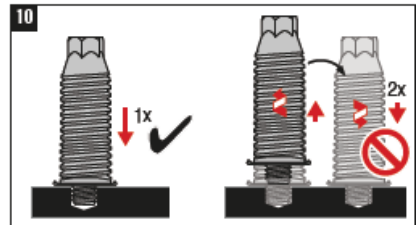
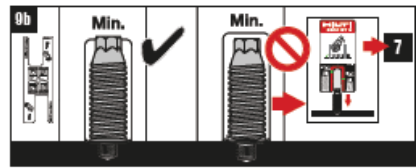
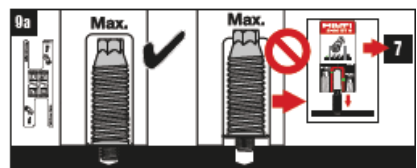
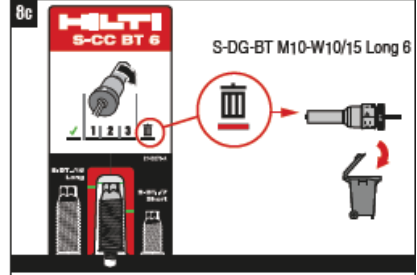
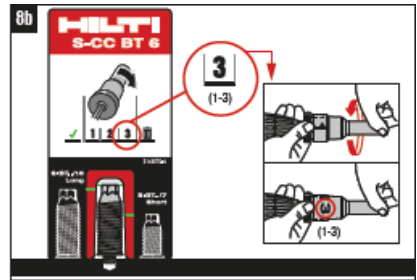
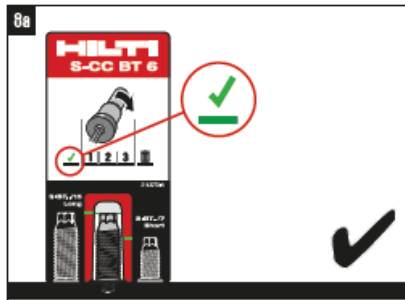
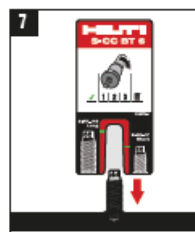
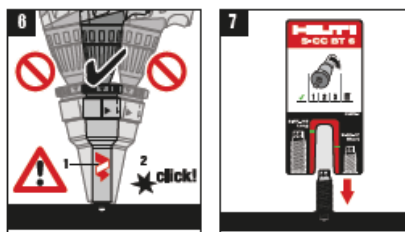
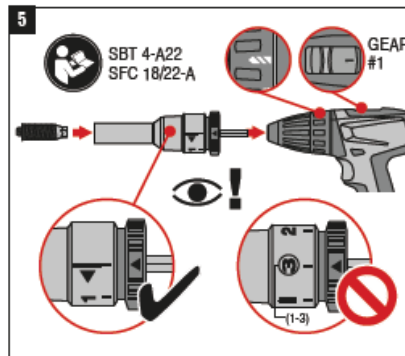
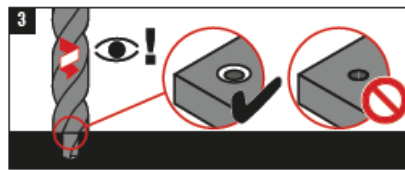
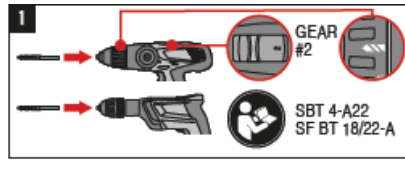
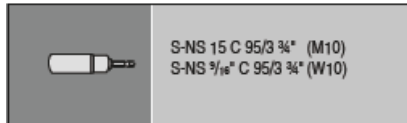
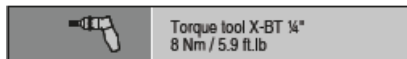

4.12 Instruction for use – S-BT-ER M6/W6/M8

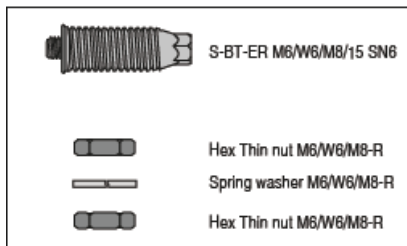
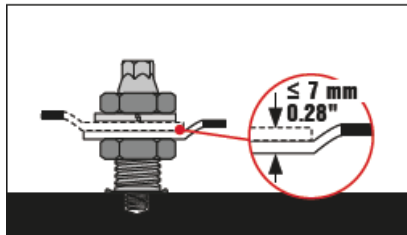
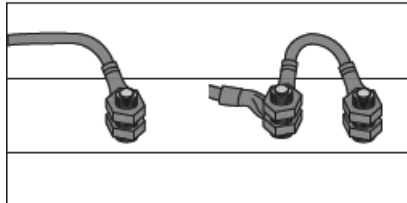
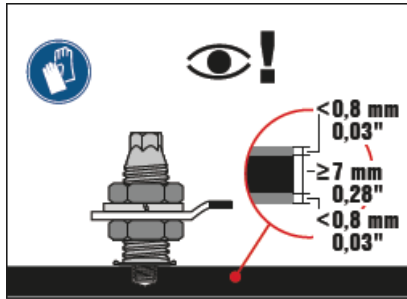

	SBT 4-A22 SF BT 18/22-A
	TS-BT 5.5-74 S
	SBT 4-A22 SFC 18/22-A
	S-DG BT M8/15 Long 6 S-DG BT M6-W6/15 Long 6
	S-CC BT 6

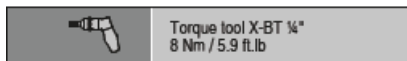

	Torque tool X-BT 1/4 8 Nm / 5.9 ft.lb
	S-NS 10 C 95/3 3/4 (M6) S-NS 5/6 C 95/3 3/4 (W6) S-NS 13 C 95/3 3/4 (M8)

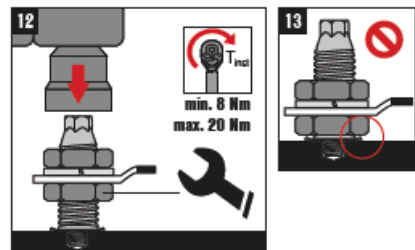
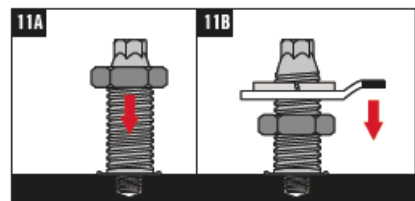
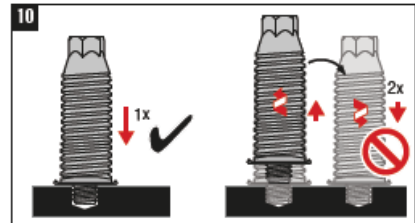
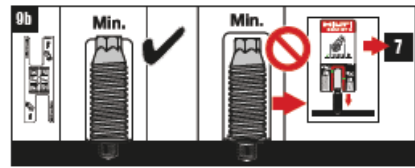
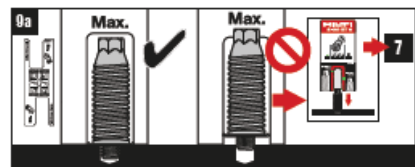
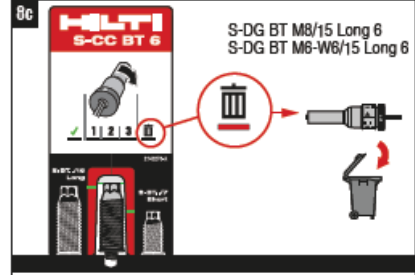
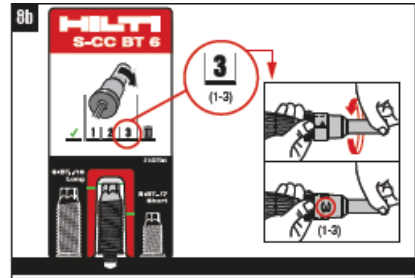
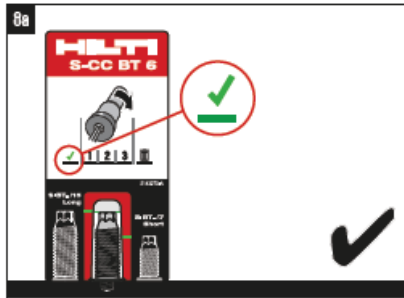
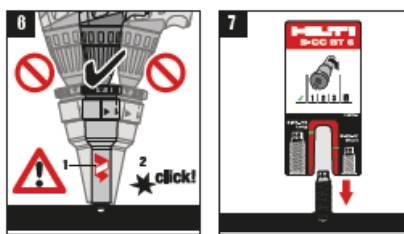
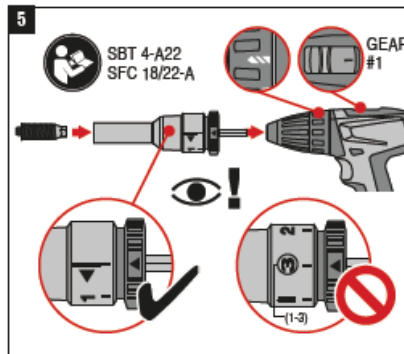
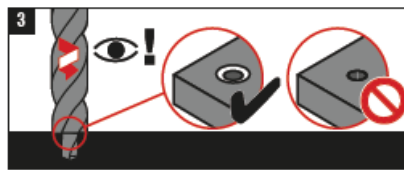
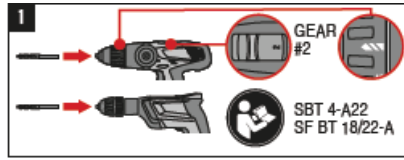

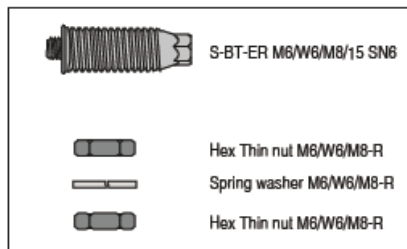
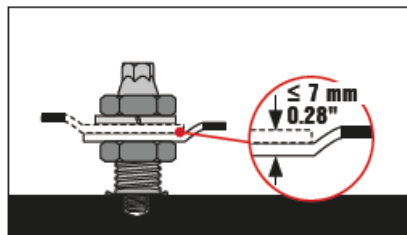
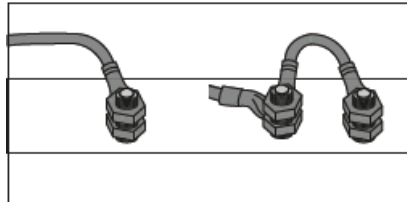
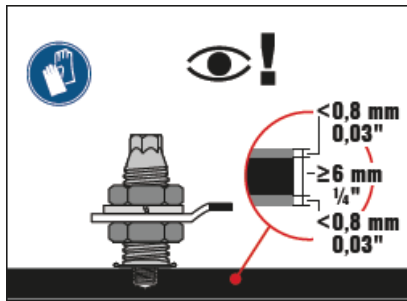

	SBT 4-A22
	TS-BT 5.5-74 S
	SBT 4-A22 SFC 18/22-A
	S-DG BT M8/15 Long 6 S-DG BT M6-W6/15 Long 6
	S-CC BT 6

	Torque tool X-BT 1/4 8 Nm / 5.9 ft.lb
--	--

	S-NS 10 C 95/3 3/4* (M6)
	S-NS 5/6 C 95/3 3/4* (W6)
	S-NS 13 C 95/3 3/4* (M8)

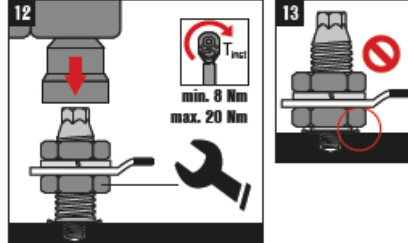
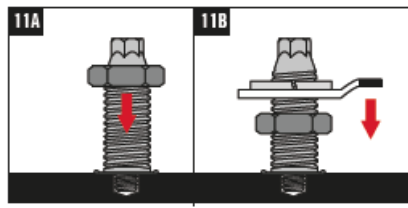
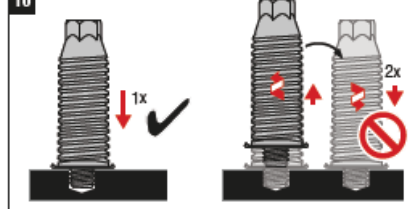
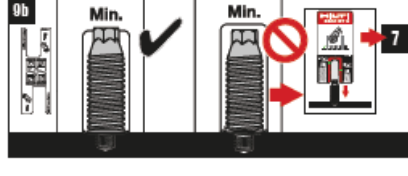
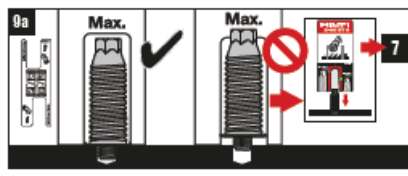
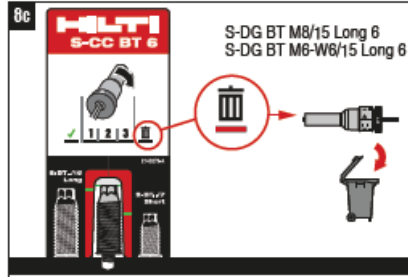
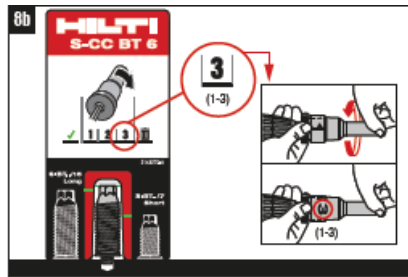
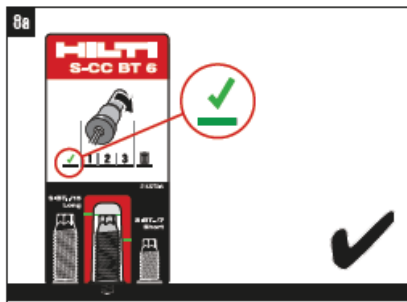
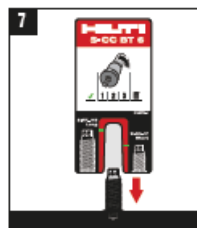
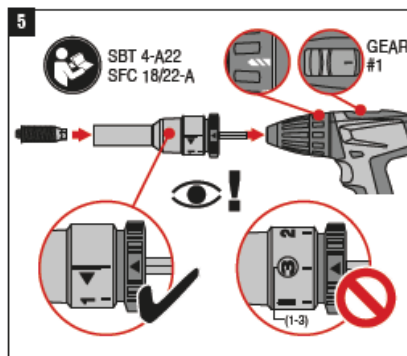
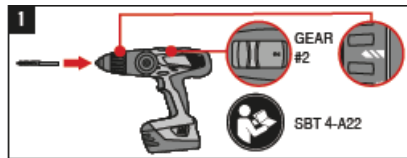

4.13 Instruction for use – S-BT-ER M10/W10

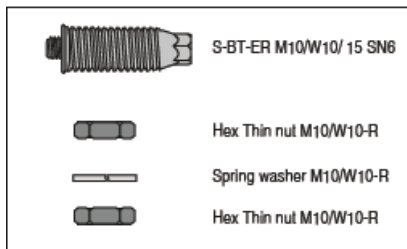
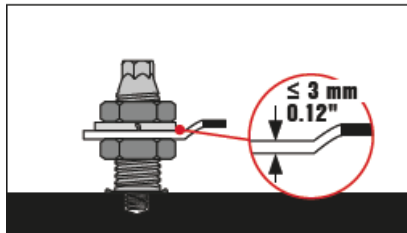
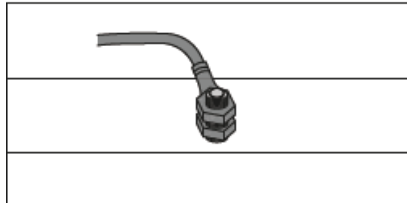
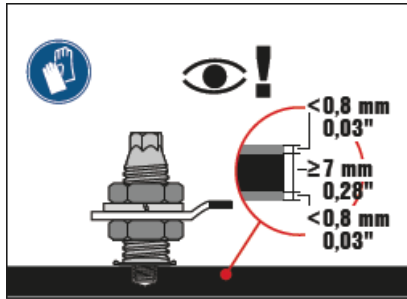

	SBT 4-A22 SF BT 18/22-A
	TS-BT 5.5-74 S
	SBT 4-A22 SFC 18/22-A
	S-DG-BT M10-W10/15 Long 6
	S-CC BT 6

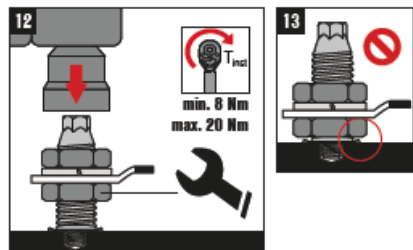
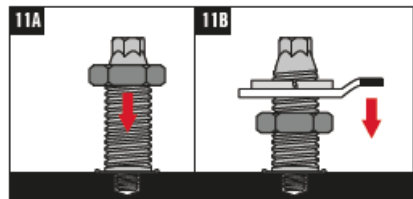
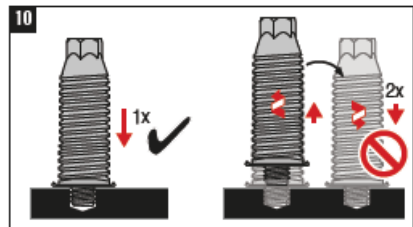
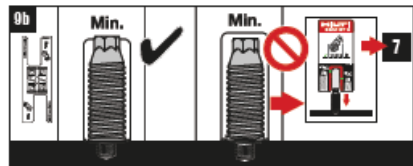
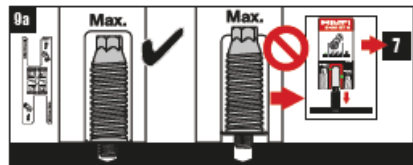
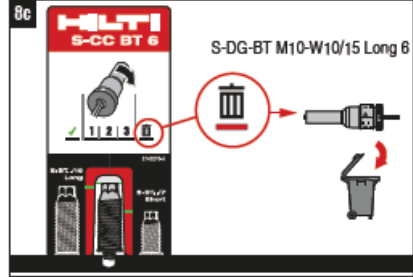
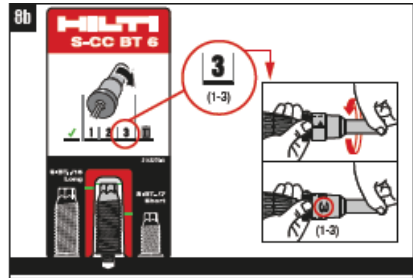
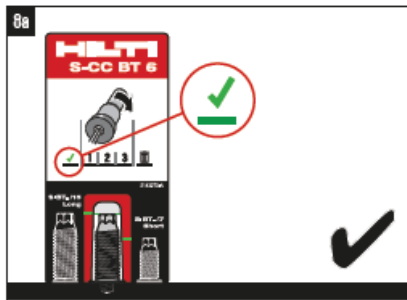
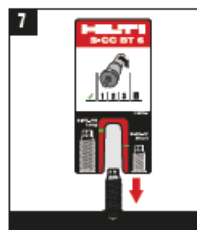
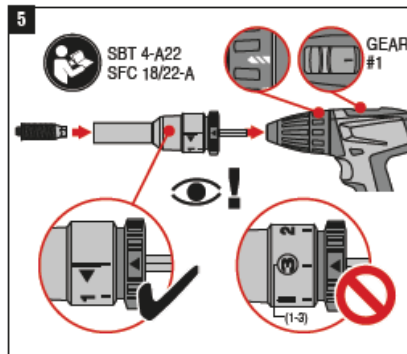
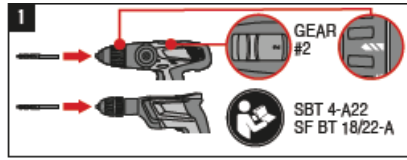
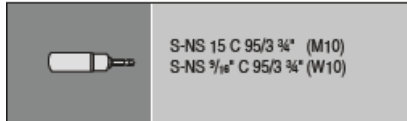
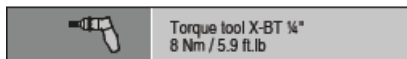

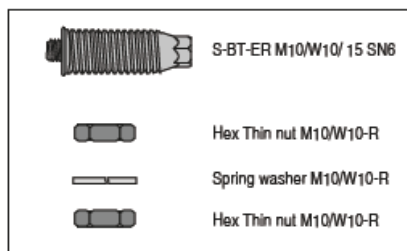
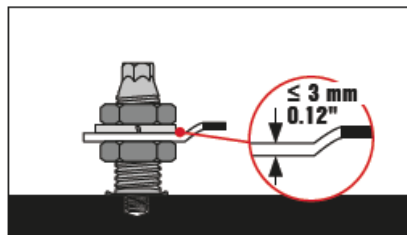
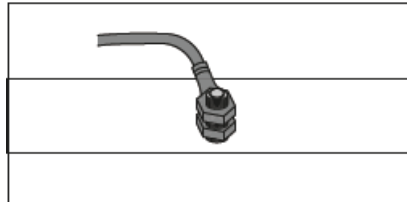
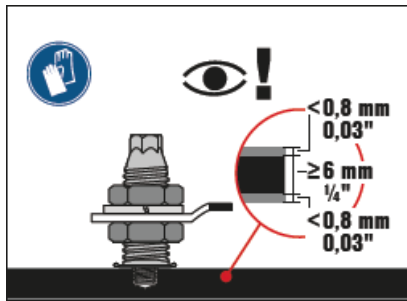

	SBT 4-A22
	TS-BT 5.5-74 S
	SBT 4-A22 SFC 18/22-A
	S-DG-BT M10-W10/15 Long 6
	S-CC BT 6

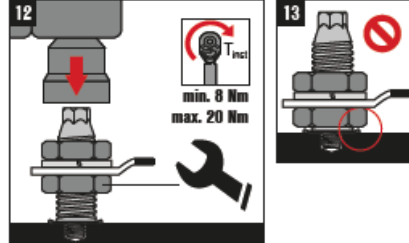
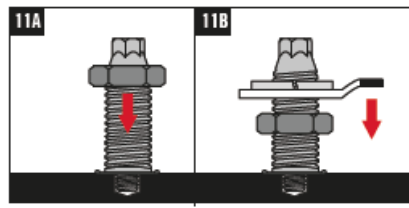
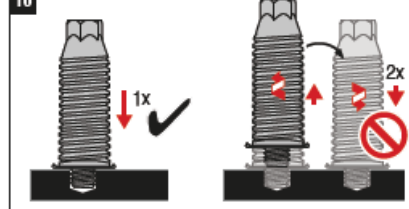
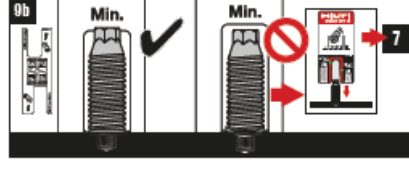
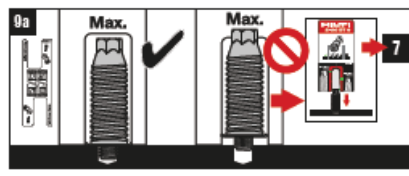
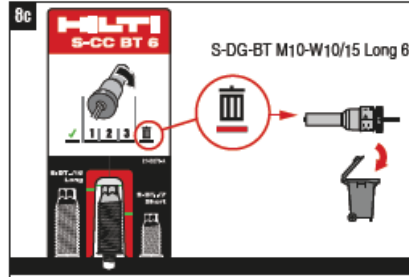
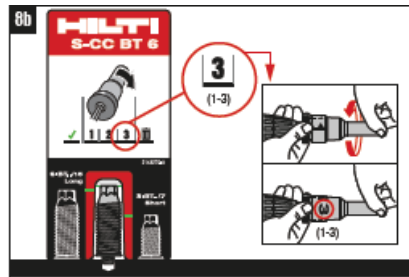
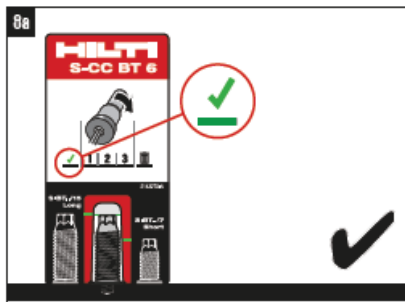
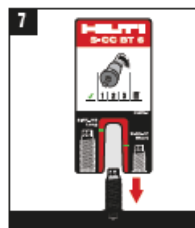
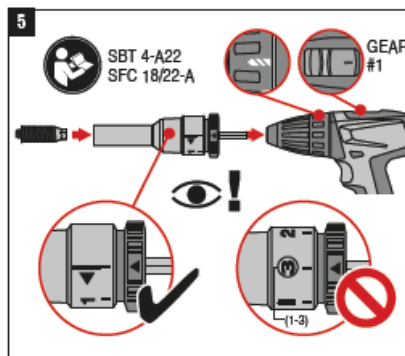
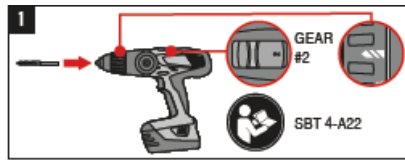
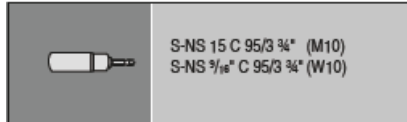
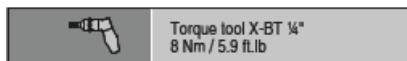

4.14 Instruction for use – S-BT-EF W10 HC 4/0 and S-BT-EF M10 HC 120

$< 0.8 \text{ mm}$
 $0.03''$
 $\geq 6 \text{ mm}$
 $1/4''$
 $< 0.8 \text{ mm}$
 $0.03''$

4

GEAR #2
SBT 4-A22

11b

3 (1-3)

5

11c

S-DG-BT M10-W10/15 HC 6

6

S-BT-EF M10/W10/15 SN 6
 Conductivity disc 35/AWG2
 Conductivity disc 120/AWG4/0
 Hex Thin nut M10/W10-F
 Spring washer M10/W10-F

7

12a

Max. 10

8

SBT 4-A22
GEAR #1

12b

Min. 10

9a

9b

click!

13

1x 2x

10

11a

14

15a

8 Nm

15b

SBT 4-A22
TT X-BT 1/4"
8 Nm

	SBT 4-A22
	TS-BT 5.5-74 S
	TS-BT HC 120/AWG4/0 TS-BT HC 35/AWG2
	S-DG BT M10-W10/15 HC 6
	S-CC BT HC 6
	Torque tool X-BT 1/4" 8 Nm / 5.9 ft.lb
	S-NS P 1/4" HKH 17 (M10) S-NS 5/8" C95/3 3/4" (W10)

4.15 Instruction for use – S-BT-ER W10 HC 4/0 and S-BT-ER M10 HC 120

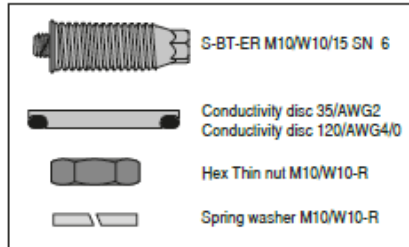
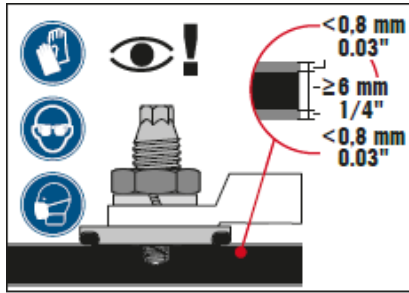

	SBT 4-A22
	TS-BT 5.5-74 S
	TS-BT HC 120/AWG40 TS-BT HC 35/AWG2
	S-DG BT M10-W10/15 HC 6
	S-CC BT HC 6

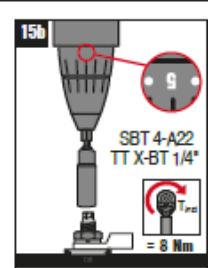
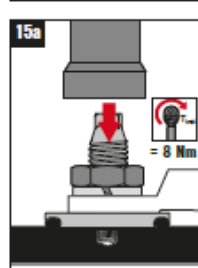
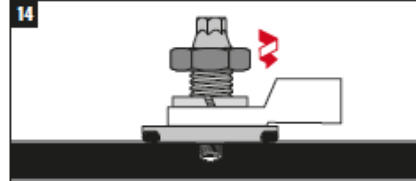
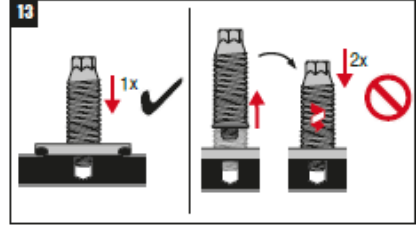
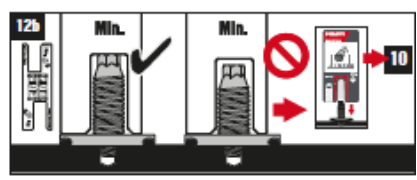
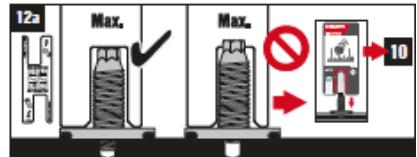
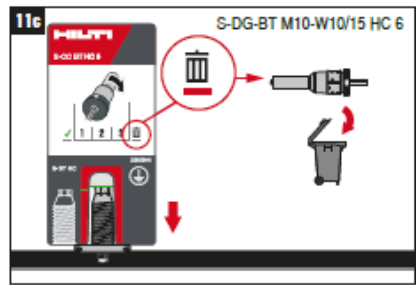
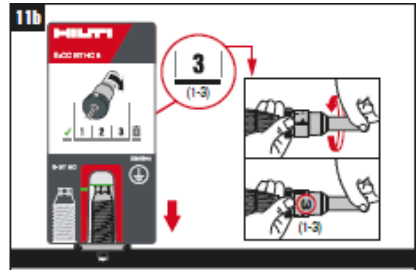
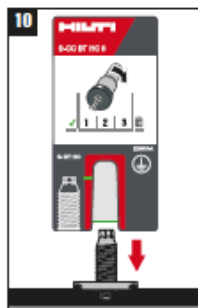
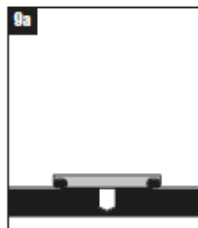
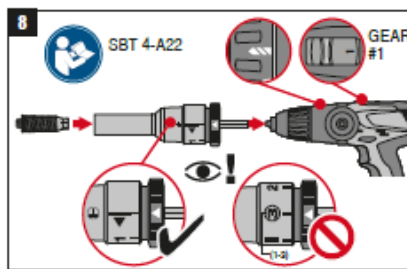
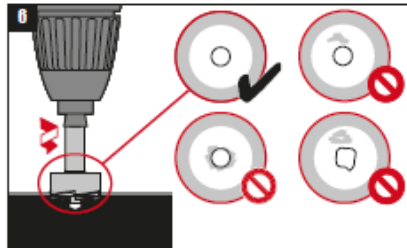
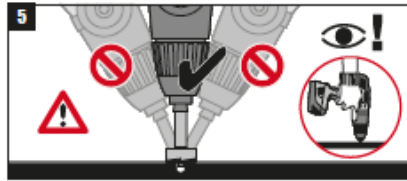
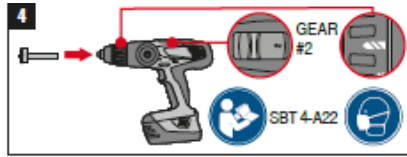
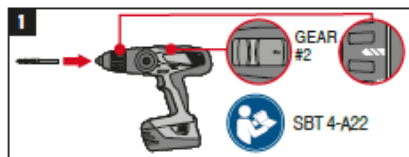
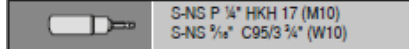
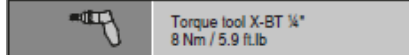

4.16 Instruction for use – Standoff adapter MF and MR 25/50/75/100 on steel with a passive fire protection (PFP) coating

4.16.1 Instruction for use – Calibration of depth gauge S-DG BT for installation of S-BT on PFP-coated steel (e.g. S-BT GR M8/7 SN 6)

2275221-10.2020

	M8 MR/MF 25 M8 MR/MF 50 M8 MR/MF 75 M8 MR/MF 100		S-NS 13/19 S-CC BT 6
	M10 MR/MF 50 W10 MR/MF 50		
	SBT 4-A22		
	S-DG BT M8/7 SHORT 6 S-DG BT M10-W10/15 LONG 6		
	Torque tool X-BT 1/4" 8 Nm / 5.9 ft.lb		
	S-BT-GR M8/7 SN 6 S-BT-GF M8/7 AN 6		
	S-BT-MR M10/W10/15 SN 6 S-BT-MF M10/W10/15 AN 6		

4.16.2 Instruction for use – Fastening of standoff adapter with S-BT on PFP-coated steel

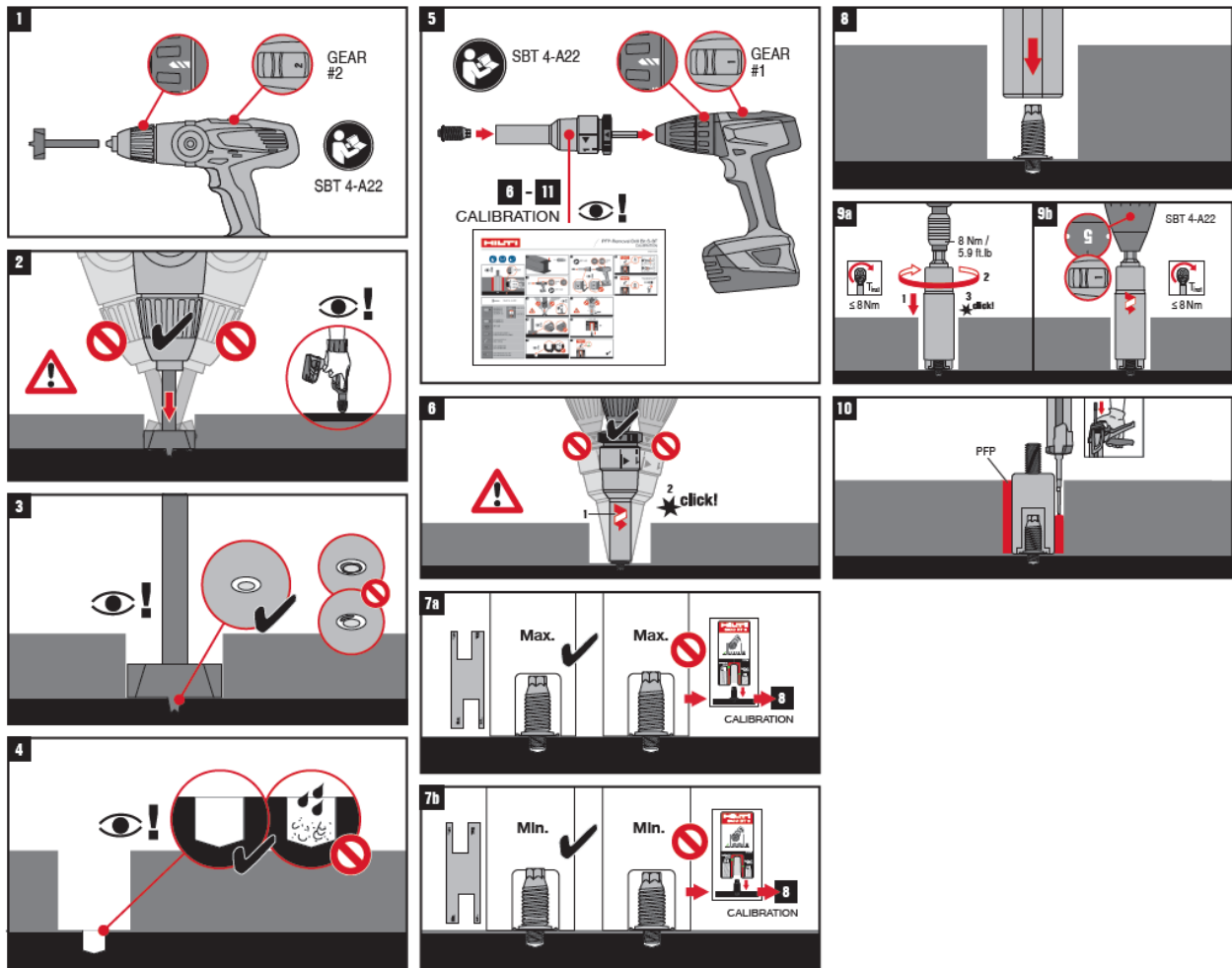

4.17 Instructions for use – Attachments to standoff adapter (e.g. M8)

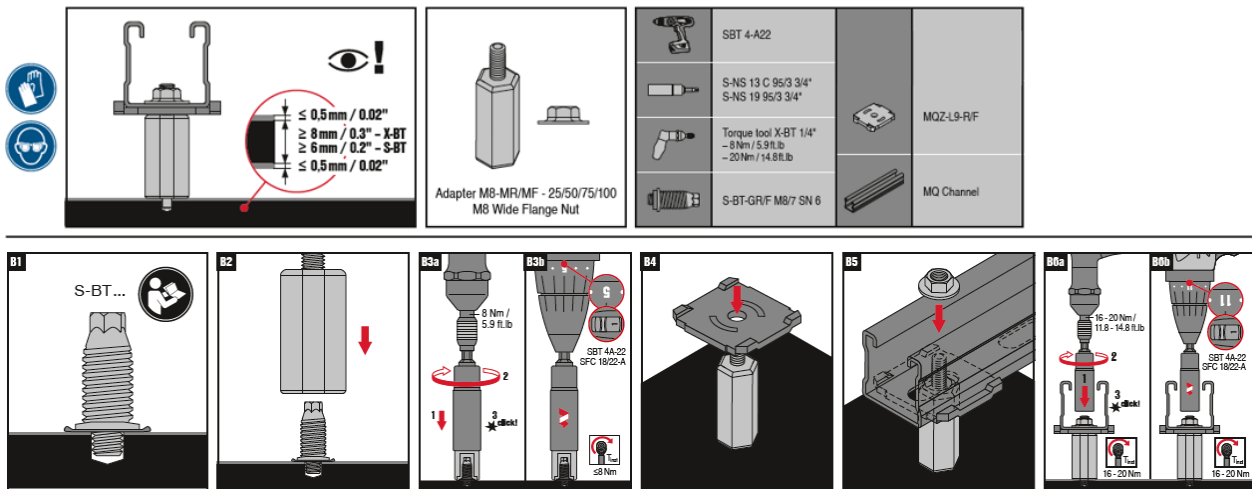

5 PERFORMANCE

5.1 Nomenclature and symbols

The symbols and nomenclature used in the technical data are listed below.

Fastener test data and performance

N and V	Tensile and shear forces in a general sense
F	Combined force (resulting from N and V) in a general sense
N_s and V_s	Tensile and shear forces in a design calculation
F_s	Combined force (resulting from N_s and V_s) in a design calculation
N_u and V_u	Ultimate tensile and shear forces that cause failure of the fastening, statistically, the reading for one specimen
N_{u,m} and V_{u,m}	Mean ultimate tensile and shear forces that cause failure of the fastening, statistically, the average for a sample of several specimens
S	The standard deviation of the sample
N_{R,k} and V_{R,k}	Characteristic tensile and shear resistance of the fastening, statistically, the 5% fractile. For example, the characteristic strength of a fastening whose ultimate strength can be described by a standard Gauss type distribution is calculated by $N_{R,k} = N_{u,m} - k \times S$ where k is a function of the sample size, n and desired confidence interval.
N_{rec} and V_{rec}	Recommended maximum tensile and shear loads of the threaded fastener tip: $N_{rec} = \frac{N_{R,k}}{\Omega}$ and $V_{rec} = \frac{V_{R,k}}{\Omega}$ where Ω is the overall factor of safety
M_{rec}	Recommended elastic moment for the fastener shank $M_{rec} = \frac{M_{R,k}}{\Omega}$ where M_{R,k} is the characteristic elastic moment resistance of the threaded fastener tip and Ω is an overall factor of safety. Unless otherwise stated on the product data sheets, the M_{rec} values in this manual include a safety factor of "1.9" for static loading.
N_{R,d} and V_{R,d}	Design tensile and shear resistance of the fastening $N_{R,d} = \frac{N_{R,k}}{\gamma_m}$ and $V_{R,d} = \frac{V_{R,k}}{\gamma_m}$ where γ_m is the partial factor of safety
T_{rec}	Recommended tightening torque [Nm or lbf ²]

Fastening details

h_{ef}	Screw-in depth of the threaded fastener tip below the surface of the base material
h_{NVS}	S-BT stud head standoff above the surface of the base material
t_i	Thickness of the fastened material
t_{II}	Thickness of the base material
Σ t_i	Total thickness of the fastened material (where more than one layer is fastened)
t_{Nut}	Thickness of the serrated flange nut

Characteristics of steel and other metals

f_y	Yield strength of metals [N/mm ² or MPa]
f_u	Ultimate tensile strength of metals [N/mm ² or MPa]

5.2 Design concepts

The recommended working loads N_{rec} and V_{rec} are generally suitable for use in typical working load designs.

Working load concept	Partial safety concept
$N_S \leq N_{rec} = \frac{N_{R,k}}{\Omega}$ <p>where Ω is an overall factor of safety including allowance for:</p> <ul style="list-style-type: none"> errors in estimation of load deviations in material and workmanship <p>and N_s is, in general, a characteristic acting load.</p> $N_S \approx N_{S,k}$	$N_{S,d} \leq N_{R,d}$ $N_{S,d} = N_{S,k} \times \gamma_F$ $N_{R,d} = \frac{N_{R,k}}{\gamma_m}$ <p>where γ_F is a partial factor of safety to allow for errors in estimation on the acting load.</p> <p>γ_m is a partial factor of safety to allow for deviations in material and workmanship.</p>

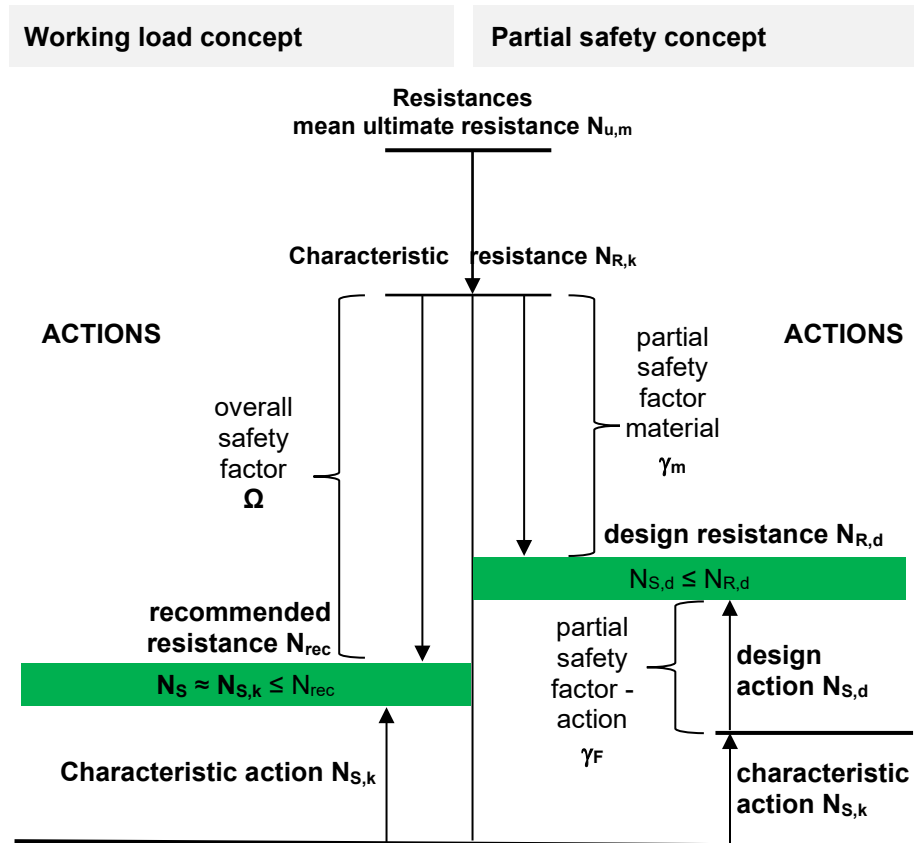

5.3 Static capacity of the S-BT threaded stud

5.3.1 Tensile load deformation behaviour of S-BT threaded stud fastenings

Tension, shear and bending tests with S-BT screw-in threaded studs, Report No. 279/15 HTL Rankweil, Bautechnische Versuchsanstalt, Febr. 2016

Base material	Steel, 6mm thick, S235 ($f_u \approx 360$ MPa) S355 ($f_u \approx 470$ MPa) Steel, 5mm thick, S235 ($f_u \approx 360$ MPa) S355 ($f_u \approx 470$ MPa) Steel, 3mm thick, S235 ($f_u \approx 360$ MPa) S235 ($f_u \approx 360$ MPa) Aluminium, 6mm thick, EN AW 5754 ($f_u \approx 270$ MPa)
Number of fastenings in test	90 50 in steel S235 30 in steel S355 10 in Aluminium

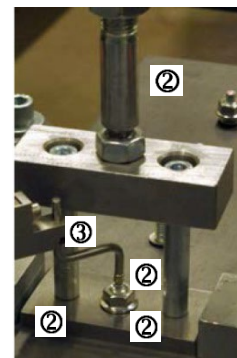
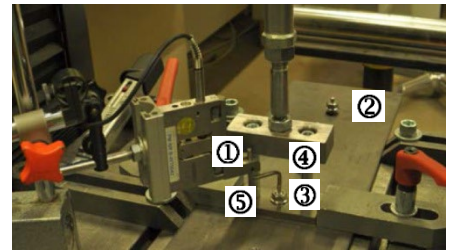
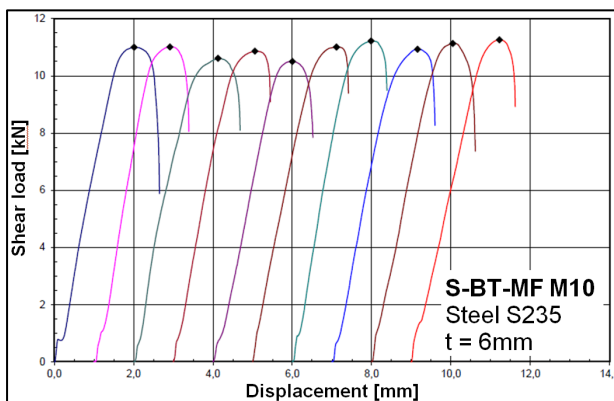
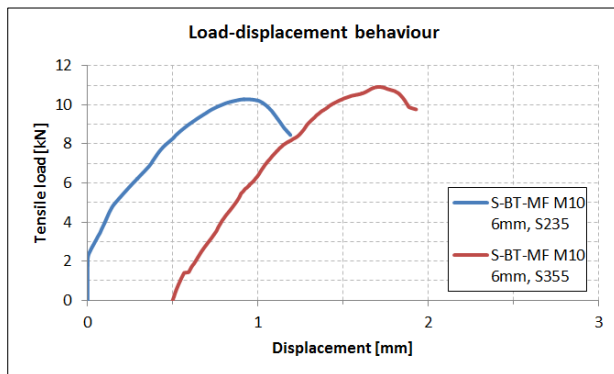

- ① Displacement gauge
- ② Base material
- ③ S-BT stud
- ④ Nut
- ⑤ Loading plate

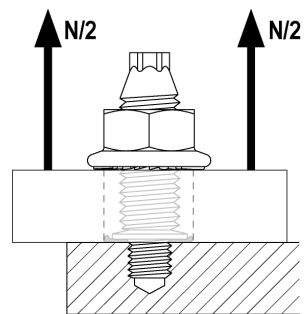

Conclusions

- Pull out strength increases with increasing base material strength and screw-in depth
- The fasteners show a well-tempered elastic behavior with a maximum displacement from 1 – 2.8 mm until the maximum load value is reached.
- Elastic stiffness is independent from the base material strength. It depends on the fastener material and base material thickness. Carbon steel fasteners behave a little stiffer than stainless steel fasteners.
- After the maximum loading capacity of the fastener is reached, no remaining load value is left due to the pull out of the tapped thread of the base material.

5.3.2 Pull out strength of S-BT threaded stud fastenings

Tension, shear and bending tests with S-BT screw-in threaded studs, Report No. 279/15 HTL Rankweil, Bautechnische Versuchsanstalt, Febr. 2016

Base material	ref. to 5.3.1
Number of fastenings in test	ref. to 5.3.1

Ultimate pull-out load

The effect of the base material type, strength and base material thickness (screw-in depth) can be observed.

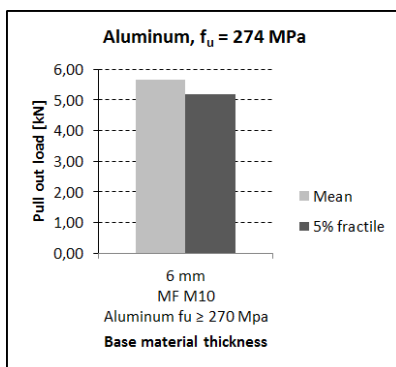
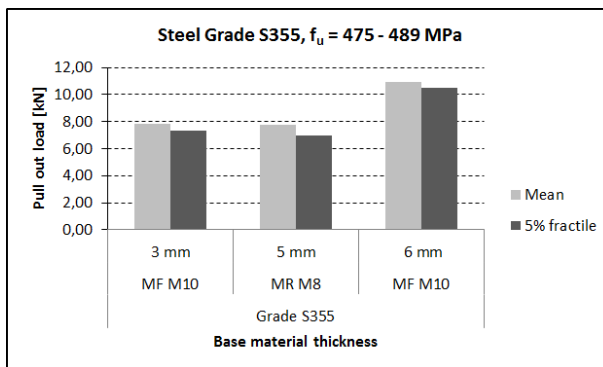
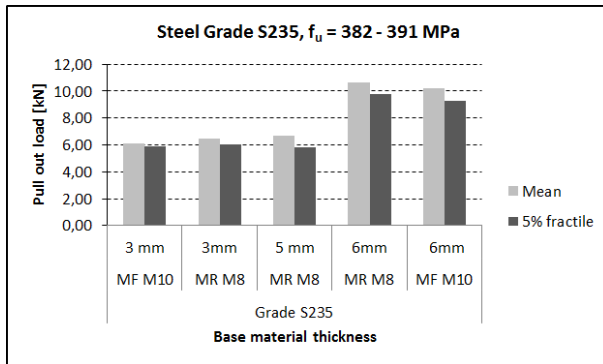
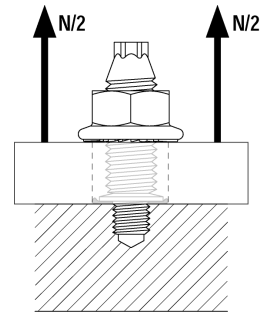

Test set up for tension tests

Conclusions

- The failure mode for all tensile tests was pull out of the fastener from the bore hole.
- The effect of the base material strength is given for all tested base metal thickness.
- The most important parameter affecting the pull-out strength is the screw-in depth and the type of the base material (steel vs. aluminum).
- The thread size of the upper part of the fastener doesn't affect the pull-out load value because the geometry of the tapping thread is identical for all studs made of the same material.

5.3.3 Shear strength of S-BT threaded stud fastenings

Tension, shear and bending tests with S-BT screw-in threaded studs, Report No. 279/15 HTL Rankweil, Bautechnische Versuchsanstalt, Febr. 2016

Base material	ref. to 5.3.1
Number of fastenings in test	ref. to 5.3.1

Ultimate shear load

The shear failure occurs through breakage of the stud in the cross section of the tap thread or through plastic deformation of the hole in the base material which leads to tilting and pull-out of fastener.

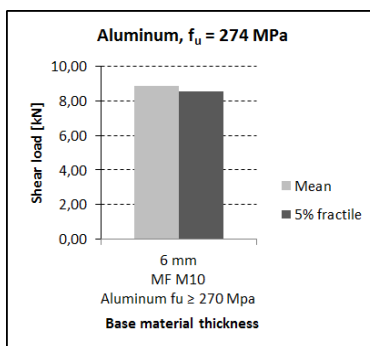
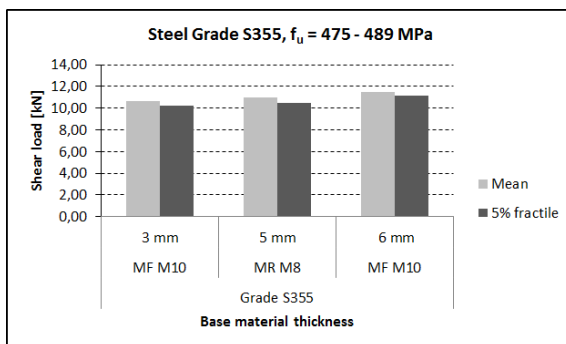
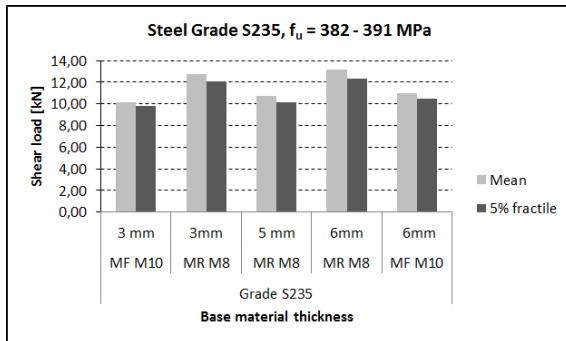
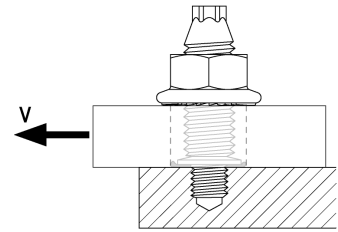

Test set up for shear load testing

Conclusions

- Failure mode of the tested S-BT studs:
85% failed due to shear fracture in the cross section of the tap thread
15 % failed due to plastic deformation of the bore hole ⇒ tilting ⇒ pull-out
- The effect of the steel base material strength is rather low.
- The most important parameters affecting the shear load capacity is the screw-in depth, the type of the base material (steel vs. aluminum) and the material of the S-BT stud.
- The thread size of the upper part of the fastener doesn't affect the shear load capacity because the geometry of the tapping thread is identical for all studs made of the same material.

5.4 S-BT in stainless steel base material

Tests at Hilti AG; Schaan 2018

General comments

Stainless steels mainly differ from non-alloy structural steels in the following properties:

- higher resistance to corrosion and acids
- higher toughness and thus poor machinability (e.g. when drilling, turning)
- lower thermal conductivity and lower electrical conductivity

The machinability of stainless steels causes some problems due to their lower thermal conductivity compared to other steels. When drilling in stainless steel, it must be taken into account that the drilling process may take longer, the drill bit may wear more quickly and it may be more difficult to form the thread in the stainless steel.

Test concept

Drilling / installation tool	SBT 4-A22
Type of drill bit:	TS-BT 5.5-74 S (standard drill bit)
Base material steel type:	Stainless steel 1.4404 (EN 10088), 316L (AISI), S31603 (UNS) 1.4362 (EN 10088), S32304 (UNS) S32003 (UNS)
Base material thickness:	10 mm (1.4404), 12 mm (1.4362)
# of bore holes:	500 drilling operations with 2 drill bits
Drilling direction:	Hand held operation, vertical and horizontal

Test results

- Even after more than 200 drill holes, the drill diameter was still within the specified tolerance range.
- The S-BT studs could easily be screwed into the base material with the installation tools recommended in the instruction for use (IFU) and section 1.2.
- The ultimate pull-out load values are on the same level compared to the load values in non-alloy structural steel.
- The thread forming torque during the screw-in process was below the specified maximum value.

Conclusions

- The standard drill bit TS-BT 5.5-74 S can be used for drilling the bore holes
- The screwdrivers listed in the instruction for use (IFU) and section 1.2 can be used for drilling the bore holes and for installing the S-BT studs.
- The load data from section 3.2 can be used for the design (steel S355).
- The maximum tensile strength of the base material made of stainless steel is limited to $f_u = 630 \text{ MPa}$ [91 ksi].

Note:

For stainless steel base material only S-BT threaded studs made of stainless steel material should be used.

Each S-BT sales box includes the corresponding TS-BT stepped drill bit. Hilti recommends disposing of the used TS-BT stepped drill bit once the complete sales packaging S-BT studs are consumed. Hilti then advises using the new stepped drill bit out of the new sales packaging.

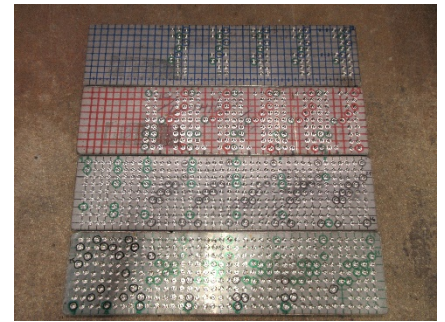

Stainless steel test plates with drilled pilot holes



Testing of pilot hole quality



Test setup to test the forming torque of the studs in stainless steel base material

5.5 Vibration effects on S-BT threaded stud fastenings

Experimental investigations on the effect of base metal vibrations on the ultimate pull-out

Report No. XSEhac-01-15_07; Hilti AG; Schaan 2015

Base material:	Steel, S235
Beam section:	HEA 100, 8 mm flange, 5 mm web
Beam span:	720 mm
Test procedure:	Beam loaded in center with F_{max} / F_{min} Step 1: $F_{max} = 59 \text{ kN}$, $F_{min} = 22 \text{ kN}$ Frequency = 6 Hz, 2 Million cycles Step 2: $F_{max} = 59 \text{ kN}$, $F_{min} = 7 \text{ kN}$ Frequency = 6 Hz, 0.5 Million cycles Step 3: $F_{max} = 10 \text{ kN}$, $F_{min} = -10 \text{ kN}$ Frequency = 30 Hz, 1.5 Million cycles Step 4: $F_{max} = 2.5 \text{ kN}$, $F_{min} = -2.5 \text{ kN}$ Frequency = 60 Hz, 5 Million cycles
Number of fastenings:	32 S-BT M8 in with FCM-disc "Grating" 32 S-BT M10 in with MQ-Channel "Multipurpose"

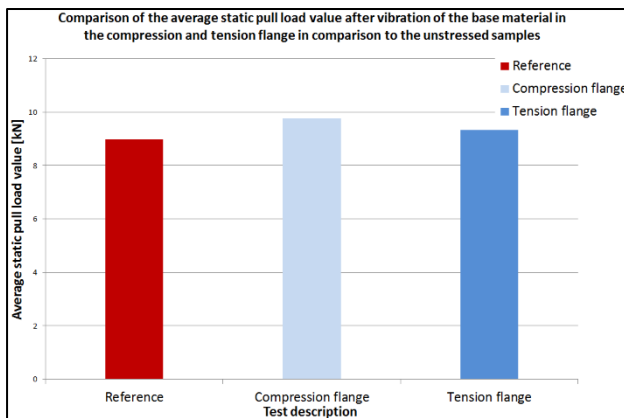
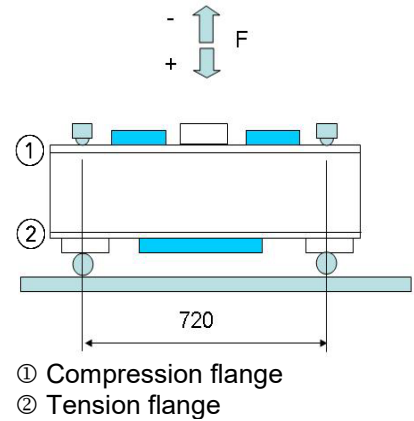

Ultimate pull-out loads of S-BT fasteners before and after cyclic loading of the steel beam

Conclusions

- Tension flange: The ultimate pull load value after the vibration test is on the same level compared to the unstressed value. No negative influence visible.
- Compression flange: The ultimate pull load value in the compressed flange is slightly higher compared to the tension flange. This could be an indicator for solidification of the thread in the compression.
- Cyclic loading applied to steel beams, which causes vibration on the fastener, as tested above did not result in loosening of grating X-FCM grating discs or loosening of S-BT studs.

Notes

- The specific test parameters and range, as detailed above, were chosen to be representative of most common vibration cases as they may occur at installation sites.
- This summary is not a complete representation of the wide range of possible vibration conditions as they may occur at specific sites. Once vibration conditions are outside this range, further verifications will be required before a clear statement can be given.

This summary is intended to be representative of the test(s) carried out. It is not intended to be a full and complete test report.

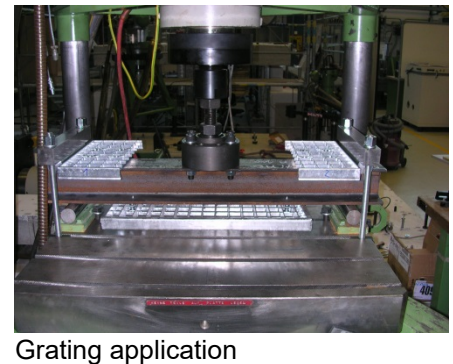
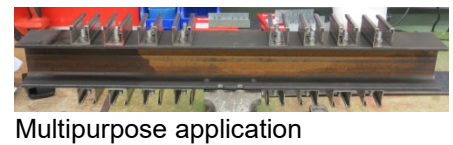

5.6 Resistance of S-BT fastenings under dynamic tensile loading

Report No. XSEhac-01-15_06; Hilti AG; Schaan 2015

General comments

The tests were performed to investigate the effect of repeated tensile loads on the anchorage of the S-BT fastenings. Therefore, Wöhler charts for S-BT fastenings have been evaluated in view of the resistance of vibrations in axial direction (repeated tensile loads).

Test concept

The S-BT fasteners were subjected to a harmonic pulsating tensile loading. The minimal load of the harmonic loading was 0.2 kN in all tests. Tests were performed at 4 different load levels. The applied maximal loads were 1.8, 3.6, 4.5 and 5.4 kN. Tests were stopped if no failure occurred within 10 million load cycles. As a testing frequency 50 Hz were chosen.

The tests were performed on the upper application limit for the base material strength (European Grade S355 with an ultimate tensile strength $f_u = 630 \text{ MPa}$) in combination with a minimum thread intersection of 0.2 mm. Minimum thread intersection is defined as the lowest tolerance field of the stud thread engagement with the base material, ref. to figure in section 0.

Test results

	Level	# tests	F_{max} [kN]	F_{min} [kN]	σ_{max} [N/mm ²]	σ_{min} [N/mm ²]	σ_{mean} [N/mm ²]	σ_a [N/mm ²]	$\Delta\sigma$ [N/mm ²]	Ratio R	Cycles N	Fail	Pass
Stainless steel 1.4462	1	5	1.8	0.2	115	12.8	63.9	51.1	102.2	0.11	12'000'000		✓
											16'000'000		✓
											12'000'000		✓
											12'000'000		✓
											11'000'000		✓
	2	5	3.6	0.2	230	12.8	121.4	108.6	217.2	0.06	2'246'724	Rupture	
											11'706'502		✓
											12'675'924		✓
											10'000'000		✓
											10'000'000		✓
	3	5	4.5	0.2	288	12.8	150.4	137.6	275.2	0.04	294'040	Pull out	
											918'680	Pull out	
											4'655'463	Rupture	
											5'617'125	Pull out	
											9'38'2038	Rupture	
	4	5	5.4	0.2	346	12.8	179.4	166.6	333.2	0.04	1'775'555	Rupture	
											788'133	Rupture	
											620'386	Rupture	
											10'000'000		✓
											3'141'580	Rupture	

Test results of fatigue tests with S-BT fasteners (1.4462) loaded with harmonic pulsating tensile loads

The intended maximum recommended tensile load of S-BT fasteners in steel S355 amounts to 2.3 kN ($\sigma_{max} = 147 \text{ N/mm}^2$). Therefore, tests were performed around this load to assess the fatigue resistance under service load conditions. At level 1 all samples passed the load level of 1.8 kN. At the second level 4 out of 5 samples passed the load level of 3.6 kN. Consequently, higher maximal loads were applied to increase the probability of failure. At level 3 and 4 the majority of the samples failed.

In all tests the governing failure mode was fatigue fracture of the S-BT stud or pull out from the base material.

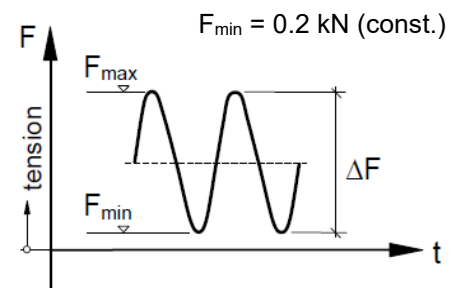
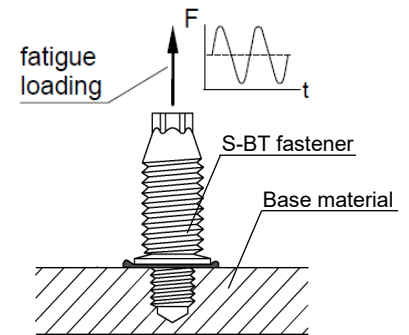

Principle sketch of cyclic tension tests

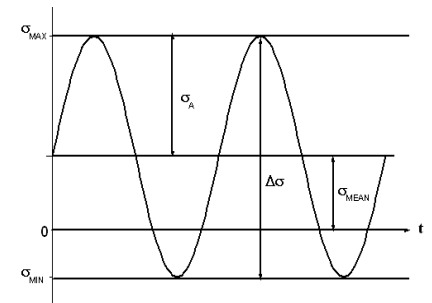

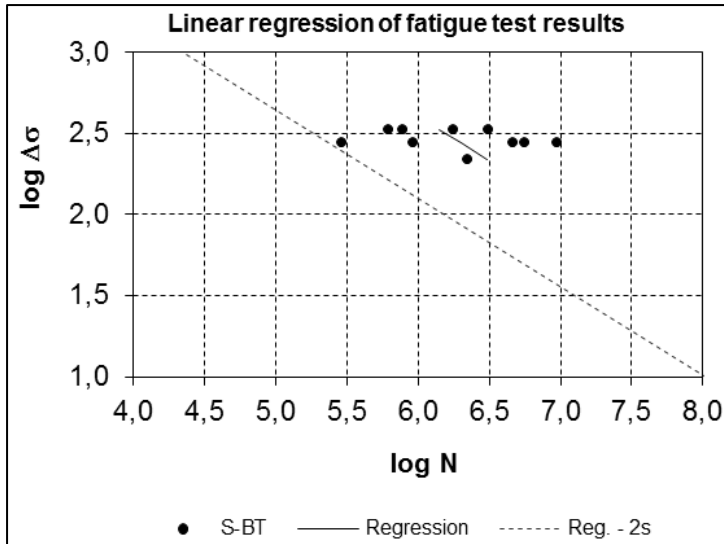

Linear regression of fatigue test results

As often done in fatigue design, the characteristic resistance $\Delta\sigma_k$ (= 5%-fractile or 95% probability of survival) is assessed by reducing the linear regression with the double of the standard deviation “s” of the test data. “s” corresponds to the standard deviation of the difference between the test results and the mean trend.

Applying this procedure, the characteristic fatigue strength determines to:

$$\log N_k = 9.8626 - 1.8396 \cdot \log \Delta\sigma_k$$

Load N_{rec} [kN]	Cycles N_k [-]	$\Delta\sigma$ [N/mm ²]	$\log \Delta\sigma$ [-]	$\log N_k$ [-]	Comment
1.8	1'175'000	115	2.062	6.070	
2.3	748'000	147	2.168	5.874	$N_{rec} = 2.3$ kN for S355 / Grade 50 steel

Characteristic cycle life N_k at tension service load level N_{rec}

Conclusions

- The values given in the table can be used for fatigue design of the stainless-steel S-BT fasteners in steel grade S355 / Grade 50.
- In case fatigue design with higher load cycles beyond 1'175'000 cycles is required, the characteristic fatigue design curve (Reg. – 2s) can be conservatively used.
- The results presented allow the use of S-BT-fasteners in applications, where wind suction is involved or to cover many typical "dynamic" parts of in principle static working loads.
- If high cycle fatigue design is necessary, the corresponding characteristics can be used to assess the principle suitability of S-BT fasteners for the specific purpose. Nevertheless, high cycle fatigue design is beyond the scope of the S-BT fasteners.

Note:

- In case of static loading, sufficient redundancy of the entire fastening must be provided.
- The values stated apply for axial tensile loading. The constructive detail has to be checked with regards to this condition. If bending stresses – for example due to imperfections – might occur, these have to be considered in fatigue design. Imperfections will lead to a reduction of the characteristic cycle lives.



Hilti S-BT fastening system under cyclic loading

- The partial safety factors for fatigue actions as well as fatigue resistance have to be considered according to fatigue design provisions (for example: Eurocode 4 or AISC-LRFD) in agreement with the statistical evaluation of N_k .
- If global safety concepts are applied, the global factors of safety have to be taken in agreement with the statistical evaluation of N_k meeting the conditions of the used design standard.

This summary is intended to be representative of the test(s) carried out. It is not intended to be a full and complete test report.

5.7 Effect of S-BT threaded stud fastenings on the fatigue strength of the base material structural steel

Report No. 2017-38X by Prof. U. Kuhlmann and Prof. H.-P. Günther from the University of Stuttgart: Fatigue classification of the constructional detail “Structural steel base material with Hilti S-BT screw-in threaded studs”, (2017) [4]

Report No. 5214011585/e, No. 5214013022/e_corr. and 5214014601/e Swiss Federal Laboratories for Materials Science and Technology (2016 and 2017) [1], [2], and [3]

General comments

When using Hilti S-BT fasteners installed into structural steel elements that are subjected to cyclic loading, the effect of the fastener on the fatigue strength of the steel base material has to be considered. Hilti has completed a comprehensive fatigue test program in order to classify the constructional detail “Structural steel base material with Hilti S-BT screw-in threaded studs” in compliance with different fatigue codes and standards, namely EN 1993-1-9 [5], AWS D1.1/D1.1M [6], ABS [7], BV [8], DNVGL-RP-C203 [9] and BS 7608 [10]. A corresponding evaluation was made by Prof. U. Kuhlmann and Prof. H.-P. Günther from the University of Stuttgart (Report No. 2017-38X, [4]).

Test Concept

9 different test series were carried out varying the following parameters which can influence the fatigue resistance:

- 5 different plate thickness' ($t = 3, 4, 6, 8$ and 20 mm),
- 2 different stress ratios ($R = +0.1$ and $+0.3$),
- 2 different installation conditions (correctly installed and fastener removed),
- 2 different fastener materials (stainless steel and carbon steel)

The steel base material was conservatively chosen to grade S235JR acc. to EN 10025-2, being aware that higher strength and fine grain steel show in general better fatigue resistance for non-welded details.

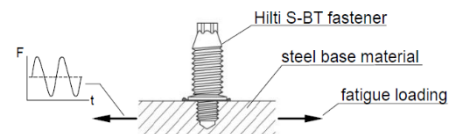

Hilti S-BT fastening system under cyclic loading

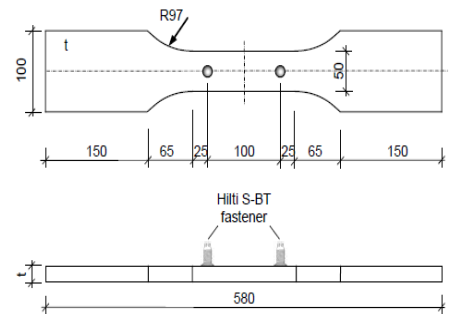

Shape and dimension of the test specimen

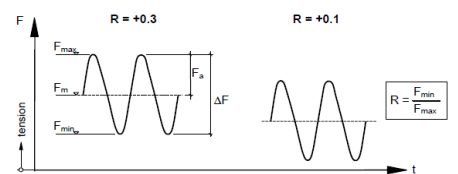

Loading condition of test specimens

Name of series	Thickness t [mm]	Stress ratio R [-]	Installation condition	# of test specimens	Report
235-03-01-ci	3	+0.1	stud correctly installed	10	[2]
235-04-01-ci	4	+0.1	stud correctly installed	10+2*	[1], [3]
235-04-01-io	4	+0.1	stud installed and overwound	7*	[3]
235-06-01-ci	6	+0.1	stud correctly installed	10	[1]
235-06-03-ci	6	+0.3	stud correctly installed	10	[3]
235-08-01-ci	8	+0.1	stud correctly installed	11+2*	[1], [2], [3]
235-08-01-ip	8	+0.1	stud installed and pulled out	9	[2]
235-08-03-ci	8	+0.3	stud correctly installed	6	[2]
235-20-01-ci	20	+0.1	stud correctly installed	10	[2]

Steel base material grade: S235JR
 Standard fastener type: S-BT-MR M8/7 SNG (stainless steel)
 * Fastener type: S-BT-MF M8/7 AN6 (carbon steel)

Table 1: Overview of the test program

Test results and evaluation procedure

The statistical evaluation of the test results and the final set-up of a fatigue reference class and S-N curve were done in three steps.

1. Determination of linear regression line (mean S-N curve) of fatigue test series
2. Determination of a characteristic design S-N curve with a certain probability of failure based on the requirements with regards to the statistical intervals (confidence level, probability of survival) as given in the specific codes and standards.
3. Recommendation of a final design S-N curve and fatigue reference class based on the afore mentioned statistical evaluation and engineering judgment taking into account the specific S-N curve types and classes as given in the relevant codes and standards.

Table 2 summarizes the results of a statistical evaluation acc. to EN 1993-1-9 combining all test results with regards to the base material thickness, stress ratio R, installation condition and fastener material.

Base material	Thickness t [mm]	Stress ratio R [-]	Installation*	No. of			Slope of S-N curve m [-]	Standard deviation s [-]	k-factor [-]	Fatigue strength at N = 2·10 ⁶	
				test specimens	data points	run-outs				mean value Δσ _m [N/mm ²]	detail category Δσ _c [N/mm ²]
S235JR	3...20	0.1-0.3	ci, io, ip	83	79	4	5.17	0.373		136.3	102.0
<small>* ci...stud correct installed io...stud installed and overwound ip...stud installed and pulled-out</small>											

Table 2: Statistical evaluation combining all test results

In Figure 1, all test data and the statistically evaluated design S-N curve are plotted in comparison to the detail category 100 (m₁ = 5) as given in EN 1993-1-9 [5] and the IIW-Recommendations [11]. Both curves fit very well, which means that the fatigue strength of Hilti S-BT fastening system can be well described by the detail category 100 (m = 5).

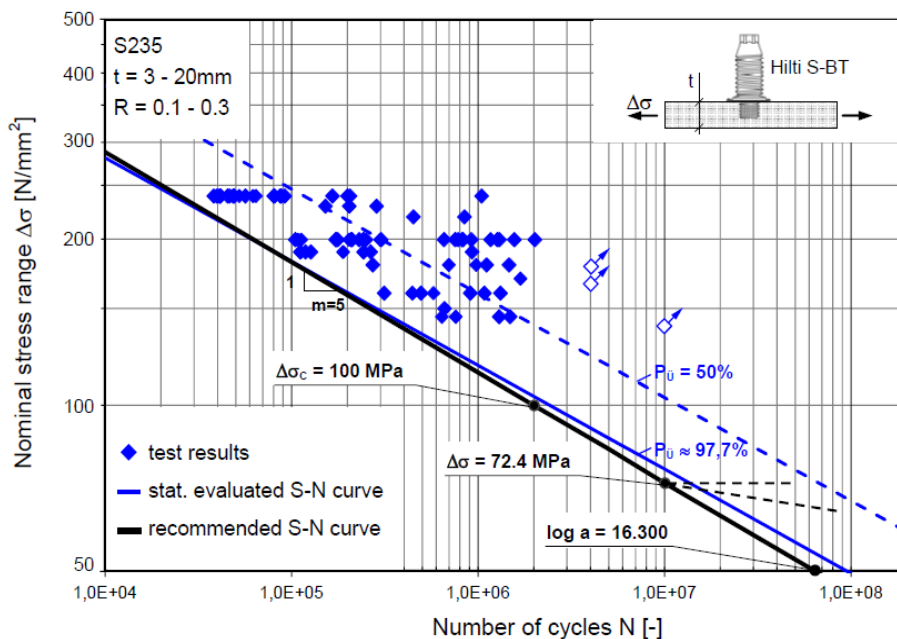
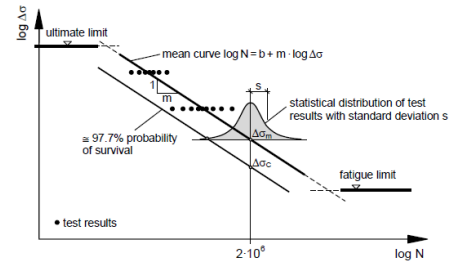
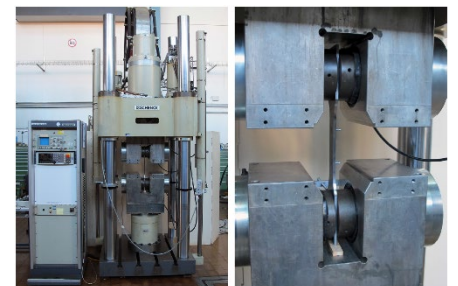

Figure 1: Statistical evaluation of all test results



Statistical evaluation acc. to EN 1993-1-9 (EC 3)



Test facility for fatigue tests

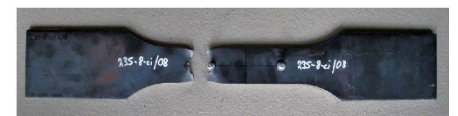

Specimen for fatigue tests

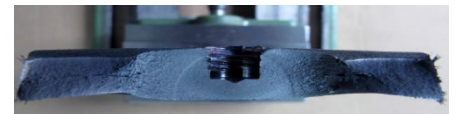

Fracture surface

Recommendation of a design S-N curve according to different codes

On the basis of the existing test results and a statistical evaluation of these test data according to the provisions given in EN 1993-1-9:2005 (Eurocode 3) it is recommended to use following general design S-N curve for the Hilti S-BT fastening system. The structural steel grades S235 up to S355 acc. to EN 10025-2, EN 10025-3 and EN 10225 are covered.

$$\log N = \log a - m \cdot \log S$$

with

log N logarithm to base 10 of corresponding number of cycles to failure N

log a = 16.300 intercept on the log N axis

m = 5.0 negative slope of S-N-curve being linear on a log-log basis

log S logarithm to base 10 of stress range $\Delta\sigma$

Number of load cycles N	Stress range $\Delta\sigma$ [MPa]
1 · 10 ⁵	181.9
1 · 10 ⁶	114.8
2 · 10 ⁶	100.0
5 · 10 ⁶	83.2
1 · 10 ⁷	72.4
1 · 10 ⁸	45.7

EN 1993-1-9:2005 (Eurocode 3)

It is recommended to use the following design S-N curve respectively detail category given in Table 3 for the constructional detail “Steel base material with Hilti S-BT screw-in threaded studs”.

Detail category	Construction detail	Description	Requirements
100 m = 5		Hilti S-BT screw-in stainless and carbon steel threaded studs with pre-drilled hole in structural steel base material. Imperfect fastener installations as e.g. overwound or pulled-out fasteners are covered.	$\Delta\sigma$ to be calculated by the gross cross-section. Installation, static loading and spacing of the fasteners only in accordance with the requirements given in [1] or [2]. Plate thickness $t \geq 3$ mm. Steel base material S235 up to S355 acc. to EN 10025-2 and EN 10025-3
[1] Hilti S-BT screw-in threaded studs. Specification Binder, Edition 01/2017 [2] Hilti Direct Fastening Technology Manual. Edition 12/2016. S-BT product pages.			

Table 3: Recommendation of fatigue S-N curve and detail category acc. to EN 1993-1-9:2005

AWS D1.1/D1.1M:2015

It is recommended to use the following design S-N curve respectively stress category termed “S-BT” given in Table 4 and Figure 2 for the constructional detail “Steel base material with Hilti S-BT screw-in threaded studs”.

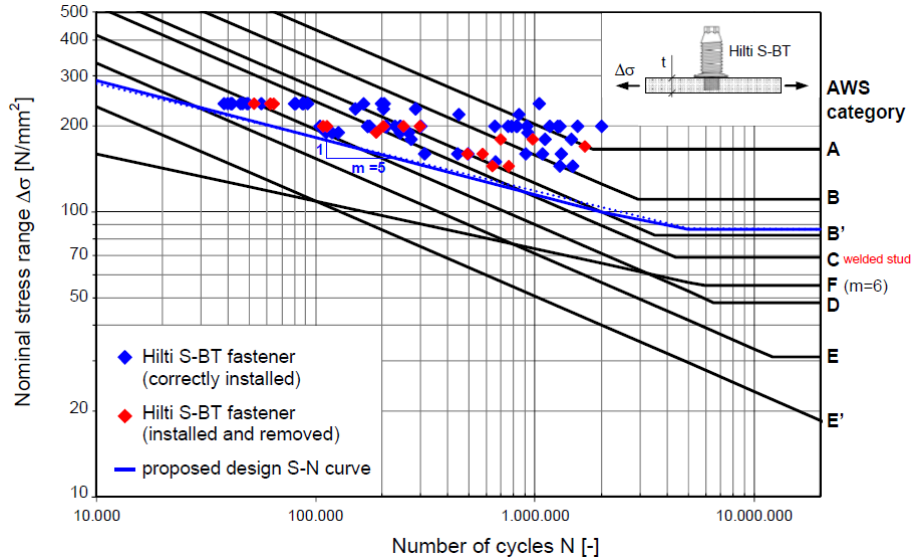

Figure 2: Comparison of Hilti S-BT fatigue test data with AWS D1.1/D1.1M:2015 fatigue categories and new proposed fatigue stress category “S-BT” for Hilti S-BT fastener

Stress Category	m	C_f		F_{TH}	
		for [ksi]	for [MPa]	[ksi]	[MPa]
A	3.0	250×10^8	8.225×10^{12}	23.9	165.0
B	3.0	120×10^8	3.948×10^{12}	16.0	110.0
B'	3.0	61×10^8	2.007×10^{12}	12.0	83.0
C	3.0	44×10^8	1.448×10^{12}	10.0	69.0
D	3.0	22×10^8	7.238×10^{11}	7.0	48.0
E	3.0	11×10^8	3.619×10^{11}	4.5	31.0
E'	3.0	39×10^8	1.283×10^{11}	2.6	18.0
F	6.0	150×10^{10}	1.650×10^{17}	8.0	55.0
S-BT	5.0	6065×10^{10}	1.995×10^{16}	12.6	87.0

Description and requirements	Stress Category	Constant C_f ksi [MPa]	Threshold F_{TH} ksi [MPa]	Slope m	Potential crack initiation	Illustrative Example
Hilti S-BT screw-in stainless and carbon steel threaded studs with pre-drilled hole in structural steel base material. Imperfect fastener installations as e.g. overwound or pulled-out fasteners are covered. $\Delta\sigma$ to be calculated by the gross cross-section. Installation, static loading and spacing of fasteners only in accordance with the requirements given in [1] or [2]. Plate thickness $t \geq 3$ mm. Steel base material up to yield strength 355 MPa.	S-BT	6065×10^{10} [1.995x10 ¹⁶]	12.6 [87.0]	5.0	At the edge or tip of the pre-drilled hole	

[1] Hilti S-BT screw-in threaded studs. Specification Binder, Edition 01/2017
 [2] Hilti Direct Fastening Technology Manual. Edition 12/2016. S-BT product pages.

Table 4: Recommendation of fatigue S-N curve and stress category acc. to AWS D1.1:2015

ABS:2014

It is recommended to use the following design S-N curve respectively stress category termed “S-BT” given in Table 5 and Figure 3 for the constructional detail “Steel base material with Hilti S-BT screw-in threaded studs”.

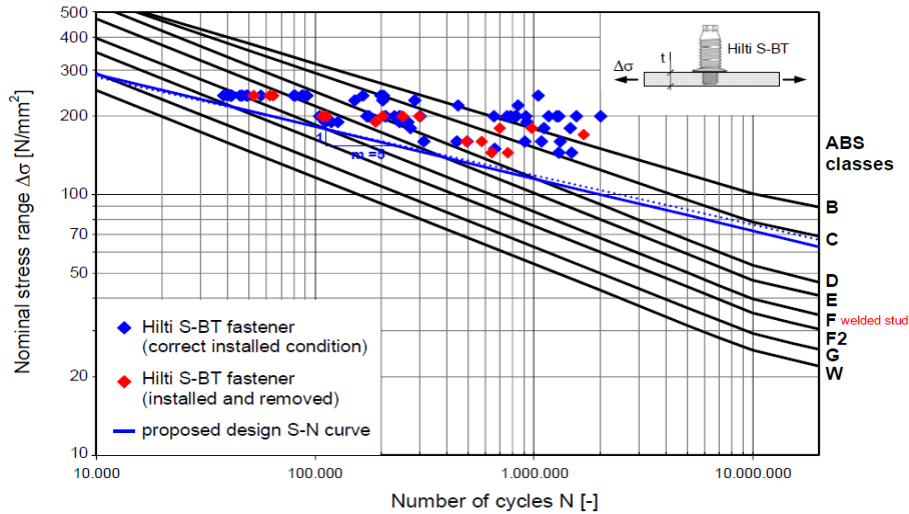

Figure 3: Comparison of Hilti S-BT fatigue test data with ABS-(A) Offshore S-N curves and new proposed fatigue class “S-BT” for Hilti S-BT fastener

Curve Class	A		m	r		N ₀	S ₀		
	for [MPa] units	for [ksi] units		for [MPa] units	for [ksi] units		for [MPa] units	for [ksi] units	
B	1.01x10 ¹⁵	4.48x10 ¹¹	4.0	1.02x10 ¹⁹	9.49x10 ¹³	6.0	1.0x10 ⁷	100.2	14.5
C	4.23x10 ¹³	4.93x10 ¹⁰	3.5	2.59x10 ¹⁷	6.35x10 ¹²	5.5	1.0x10 ⁷	78.2	11.4
D	1.52x10 ¹²	4.65x10 ⁹	3.0	4.33x10 ¹⁵	2.79x10 ¹¹	5.0	1.0x10 ⁷	53.4	7.75
E	1.04x10 ¹²	3.18x10 ⁹	3.0	2.30x10 ¹⁵	1.48x10 ¹¹	5.0	1.0x10 ⁷	47.0	6.83
F	6.30x10 ¹¹	1.93x10 ⁹	3.0	9.97x10 ¹⁴	6.24x10 ¹⁰	5.0	1.0x10 ⁷	39.8	5.78
F2	4.30x10 ¹¹	1.31x10 ⁹	3.0	5.28x10 ¹⁴	3.40x10 ¹⁰	5.0	1.0x10 ⁷	35.0	5.08
G	2.50x10 ¹¹	7.64x10 ⁸	3.0	2.14x10 ¹⁴	1.38x10 ¹⁰	5.0	1.0x10 ⁷	29.2	4.24
W	1.60x10 ¹¹	4.89x10 ⁸	3.0	1.02x10 ¹⁴	6.54x10 ⁹	5.0	1.0x10 ⁷	25.2	3.66
S-BT	1.995x10¹⁶	1.28x10¹²	5.0	1.995x10¹⁶	1.28x10¹²	5.0	1.0x10⁷	72.4	10.50

Description and notes on mode of failure	Class	Explanatory comments	Example including failure modes
Hilti S-BT screw-in stainless and carbon steel threaded studs with pre-drilled hole in structural steel base material. Imperfect fastener installations as e.g. overwound or pulled-out fasteners are covered. Potential crack initiation at the edge or tip of the pre-drilled hole.	S-BT	Δσ to be calculated by the gross cross-section. Installation, static loading and spacing of fasteners only in accordance with the requirements given in [1] or [2]. Plate thickness t ≥ 3 mm. Steel base material up to yield strength 355 MPa.	

Parameter of design S-N curve class S-BT									
Curve Class	A		m	r		N ₀	S ₀		
	for [MPa] units	for [ksi] units		for [MPa] units	for [ksi] units		for [MPa] units	for [ksi] units	
S-BT	1.995x10 ¹⁶	1.28x10 ¹²	5.0	1.995x10 ¹⁶	1.28x10 ¹²	5.0	1.0x10 ⁷	72.4	10.50

[1] Hilti S-BT screw-in threaded studs. Specification Binder, Edition 01/2017
 [2] Hilti Direct Fastening Technology Manual. Edition 12/2016. S-BT product pages.

Table 5: Recommendation of fatigue S-N curve and fatigue class acc. to ABS-(A):2014

BV:2016

It is recommended to use the following design S-N curve respectively stress category termed “S-BT” given in Table 6 and Figure 4 for the constructional detail “Steel base material with Hilti S-BT screw-in threaded studs”.

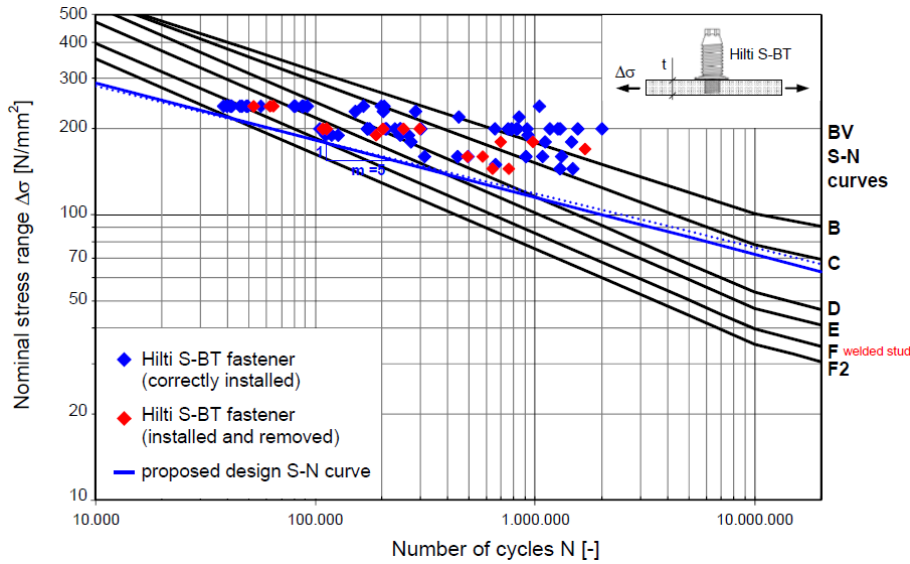

Figure 4: Comparison of Hilti S-BT fatigue test data with BV:2016 fatigue curves and new proposed fatigue curve “S-BT” for Hilti S-BT fastener

Curve	FAT	First slope		Slope intersection		Second slope		Reference thick-ness t_{ref} [mm]	Thickness exponent n	
	ΔS [MPa]	m_1	$\log_{10}(K_1)$	N cycles	ΔS_q [MPa]	m_2	$\log_{10}(K_2)$			
B	150.00	4.0	15.0056	10^7	100.32	7	21.0105	25	0	
C	123.81	3.5	13.6260	10^7	78.19	6	18.3589		see Sec. 10, Tab. 2 of BV	
D	91.25	3.0	12.18.18	10^7	53.36	5	15.6363			
E (1)	80.31	3.0	12.0153	10^7	46.96	5	15.3588			
F (1)	68.10	3.0	11.8004	10^7	39.82	5	15.0007			
F2 (1)	59.95	3.0	11.6345	10^7	35.06	5	14.7241			
P _I	91.25	3.0	12.1818	10^7	53.36	5	15.6363			
P _{II}	100.00	3.0	12.3010	10^7	58.48	5	15.8350			
S-BT	100.00	5.0	16.3000	10^7	72.40	5	16.3000		25	0

Joint and detail description	Curve	Geometry	Requirements
Hilti S-BT screw-in stainless and carbon steel threaded studs with pre-drilled hole in structural steel base material. Imperfect fastener installations as e.g. overwound or pulled-out fasteners are covered. Potential crack initiation at the edge or tip of the pre-drilled hole.	S-BT		$\Delta\sigma$ to be calculated by the gross cross-section. Installation, static loading and spacing of fasteners only in accordance with the requirements given in [1] or [2]. Plate thickness $t \geq 3$ mm. Steel base material up to yield strength 355 MPa.

Parameter of design S-N curve S-BT								
Curve	FAT	First slope		Slope intersection		Second slope		Thickness exponent n
	ΔS [MPa]	m_1	$\log_{10}(K_1)$	N cycles	ΔS_q [MPa]	m_2	$\log_{10}(K_2)$	
S-BT	100	5.0	16.300	10^7	72.40	5.0	16.300	0

[1] Hilti S-BT screw-in threaded studs. Specification Binder, Edition 01/2017
 [2] Hilti Direct Fastening Technology Manual. Edition 12/2016. S-BT product pages.

Table 6: Recommendation of fatigue design S-N curve and stress category acc. to BV:2016, air

DNVGL-RP-C203:2016

It is recommended to use the following design S-N curve respectively stress category termed “S-BT” given in Table 7 and Figure 5 for the constructional detail “Steel base material with Hilti S-BT screw-in threaded studs”.

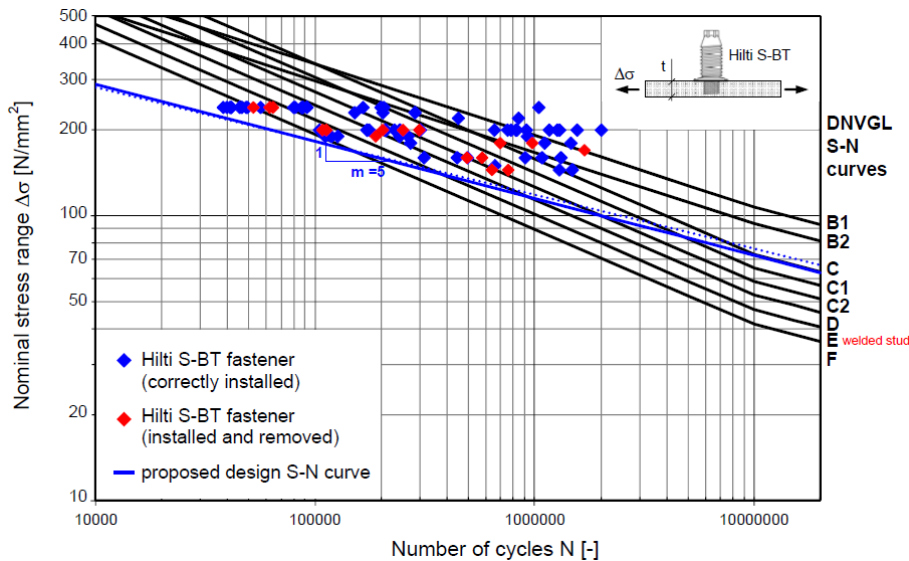

Figure 5: Comparison of Hilti S-BT fatigue test data with DNVGL-RP-C203:2016 fatigue curves and new proposed fatigue curve “S-BT” for Hilti S-BT fastener

S-N curve	N ≤ 10 ⁷ cycles		N > 10 ⁷ cycles	Fatigue limit at 10 ⁷ cycles [MPa]	Tickness exponent k
	m ₁	log a ₁	log a ₂ m ₂ = 5.0		
B1	4.0	15.117	17.146	106.97	0
B2	4.0	14.885	16.858	93.59	0
C	3.0	12.592	16.320	73.10	0.05
C1	3.0	12.449	16.081	65.50	0.10
C2	3.0	12.301	15.835	58.48	0.15
D	3.0	12.164	15.606	52.63	0.20
E	3.0	12.010	15.350	46.78	0.20
F	3.0	11.855	15.091	41.52	0.25
F1	3.0	11.699	14.832	36.84	0.25
F3	3.0	11.546	14.576	32.75	0.25
S-BT	5.0	16.300	16.300	72.4	0

Detail category	Construction detail	Description	Requirements		
S-BT		Hilti S-BT screw-in stainless and carbon steel threaded studs with pre-drilled hole in structural steel base material. Imperfect fastener installations as e.g. overwound or pulled-out fasteners are covered.	Δσ to be calculated by the gross cross-section. Installation, static loading and spacing of fasteners only in accordance with the requirements given in [1] or [2]. Plate thickness t ≥ 3 mm. Steel base material up to yield strength 355 MPa.		
Parameter of S-N curve for detail category S-BT					
Detail category	N ≤ 10 ⁷ cycles		N > 10 ⁷ cycles	Fatigue limit at 10 ⁷ cycles [MPa]	Thickness exponent k
S-BT	m ₁	log a ₁	log a ₂ m ₂ = 5.0		
S-BT	5.0	16.300	16.300	72.4	0

[1] Hilti S-BT screw-in threaded studs. Specification Binder, Edition 01/2017
 [2] Hilti Direct Fastening Technology Manual, Edition 12/2016. S-BT product pages.

Table 7: Recommendation of fatigue S-N curve and detail category acc. to DNVGL-RP-C203, air

BS 7608:2014

It is recommended to use the following design S-N curve respectively stress category termed “S-BT” given in Table 8 and Figure 6 for the constructional detail “Steel base material with Hilti S-BT screw-in threaded studs”.

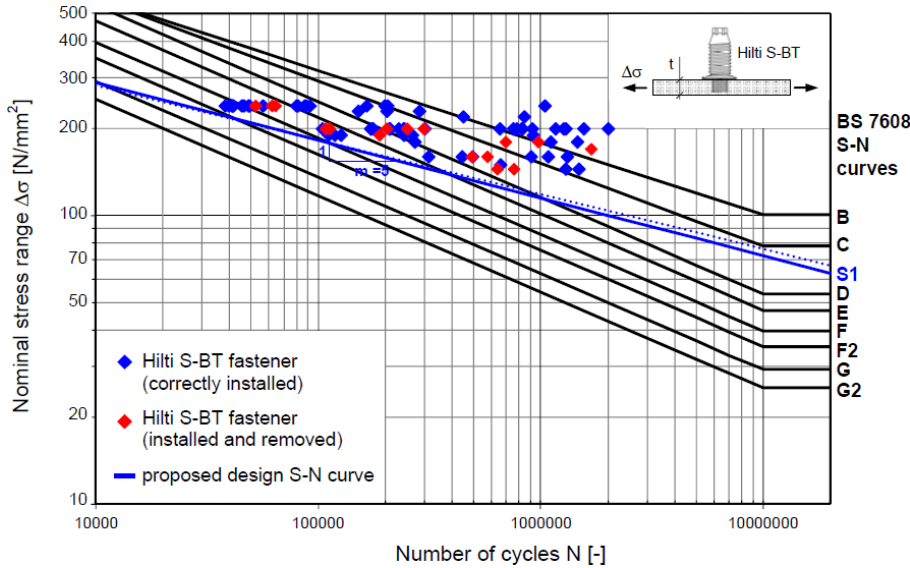

Figure 6: Comparison of Hilti S-BT fatigue test data with BS 7608:2014 fatigue curves and new proposed fatigue curve “S-BT” for Hilti S-BT fastener

Class	C ₀	log ₁₀ C ₀	m	SD Stand. Deviation of log ₁₀ N ₁	C ₂	S _{gc} (N=10 ⁷ cyc.) N/mm ²	S _{oy} (N=5·10 ⁷ cyc.) N/mm ²
B	2.343·10 ¹⁵	15.3697	4.0	0.1821	1.01·10 ¹⁵	100	67
C	1.082·10 ¹⁴	14.0344	3.0	0.2041	4.23·10 ¹³	78	49
D	3.988·10 ¹²	12.6008	3.0	0.2095	1.52·10 ¹²	53	31
E	3.2893·10 ¹²	12.5171	3.0	0.2509	1.04·10 ¹²	47	27
F	1.726·10 ¹²	12.2371	3.0	0.2183	6.32·10 ¹¹	40	23
F2	1.231·10 ¹²	12.0902	3.0	0.2279	4.31·10 ¹¹	35	21
G	5.656·10 ¹¹	11.7526	3.0	0.1793	2.48·10 ¹¹	29	17
G2	3.907·10 ¹¹	11.5918	3.0	0.1952	1.59·10 ¹¹	25	15
S1	5.902·10 ¹⁶	16.7710	5.0	0.2350	2.00·10 ¹⁶	46 (10 ⁸ cyc.)	46 (10 ⁸ cyc.)
S2	3.949·10 ¹⁶	16.5965	5.0	0.3900	6.55·10 ¹⁵	37 (10 ⁸ cyc.)	37 (10 ⁸ cyc.)
S-BT	5.902·10¹⁶	16.7710	5.0	0.2350	2.00·10¹⁶	74.2	52.5

Design S-N curve: $\log N = \log_{10} C_0 - 2 \cdot SD - m \cdot \log S$

Product form	Location of crack	Detail	Manufacturing requirements	Special requirements	Design stress area	Class	Notes	Sketch
Rolled steel plates and sections	At the edge or tip of the pre-drilled hole	Hilti S-BT screw-in stainless and carbon steel threaded studs with pre-drilled hole in structural steel base material.	Installation, static loading and spacing of fasteners only in accordance with the requirements given in [1] or [2].	Plate thickness $t \geq 3$ mm. Steel base material up to yield strength 355 MPa.	Net cross section	S-BT (S1)	Imperfect fastener installations as e.g. overwound or pulled-out fasteners are covered.	
Parameter of S-N curve for detail class S-BT								
Class	C ₀	log ₁₀ C ₀	m	SD Stand. Deviation of log ₁₀ N	C ₂	S _{gc} (N=10 ⁷ cyc.) N/mm ²	S _{oy} (N=5·10 ⁷ cyc.) N/mm ²	
S-BT	5.902·10 ¹⁶	16.7710	5.0	0.2350	2.00·10 ¹⁶	74.2	52.5	

[1] Hilti S-BT screw-in threaded studs. Specification Binder, Edition 01/2017
 [2] Hilti Direct Fastening Technology Manual. Edition 12/2016. S-BT product pages.

Table 8: Recommendation of fatigue S-N curve and detail category acc. to BS 7608:2014

Literature:

- [1] EMPA: Test Report No. 5214011585/e. Swiss Federal Laboratories for Materials Testing and Research (EMPA), April 26th 2016.
- [2] EMPA: Test Report No. 5214013022/e_corr. Swiss Federal Laboratories for Materials Testing and Research (EMPA), June 29th 2017.
- [3] EMPA: Test Report No. 5214014601/e. Swiss Federal Laboratories for Materials Testing and Research (EMPA), April 11th 2017.
- [4] Kuhlmann, U., Günther, H.-P.: Fatigue classification of the constructional detail "Structural steel base material with Hilti S-BT screw-in threaded studs". Universität Stuttgart, Institut für Konstruktion und Entwurf, June 30th, 2017, Nr. 2017-38X.
- [5] EN 1993-1-9: Eurocode 3: Design of steel structures - Part 1-9: Fatigue, European Committee for Standardization.
- [6] AWS D1.1: Structural Welding Code – Steel, American Welding Society.
- [7] ABS: Guide for Fatigue Assessment of Offshore Structures. American Bureau of Shipping. 2003, Updated version February 2014.
- [8] BV: Guidelines for Fatigue Assessment of Steel Ships and Offshore Units. Bureau Veritas. September 2016.
- [9] DNV-GL-RP-C203: Recommended Practice – Fatigue design of offshore steel structures. Det Norske Veritas, Germanischer Lloyd. Edition 2016.
- [10] BS 7608: Guide to fatigue design and assessment of steel products.
- [11] IIW: Hobbacher, A.: Fatigue recommendations for fatigue design of welded joints and components. International Institute of Welding (IIW), XIII-1539-96 / XV-845-95 document, May 2007.

5.8 Influence of glue coatings on the loosening torque

Experimental investigations on the influence of glue coatings on the loosening torque

Report No. XSEhac-01-15_15; Hilti AG; Schaan 2015

General comments

The design intent is that the nut can be removed without the S-BT stud unscrewing from the base material. To increase the loosening torque of the stud from the base material, the stainless steel and carbon steel S-BT fasteners are equipped with a “micro encapsulation” on the tapping thread. This helps to increase the loosening torque compared to uncoated fasteners.

Test concept

The test program included in summary 100 specimen for 20 test series. Various coating types have been tested in combination with variable thread intersections. The influence of the screw-in depth was tested for the complete screw-in depth range of the S-BT fastener. As a final parameter, the influence of the maximum and minimum base material strength was tested.

Test results

Thread intersection: For all tested thread intersections an increase of the loosening torque was visible due to the coating.

Screw-in depth: Based on the test results, the effect of the glue coating decreased with lower screw-in depth.

Base material strength: No significant influence could be found.

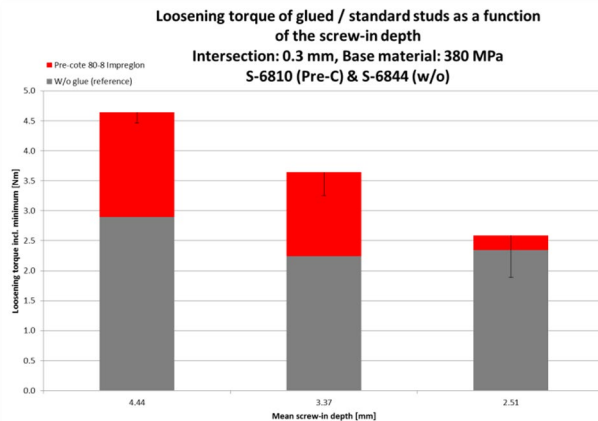

Conclusions

- For 6 mm base material, a loosening torque of 3.6 to 4.6 Nm can be achieved.
- For 5 mm base material, a loosening torque of 2.5 to 3.6 Nm can be achieved
- Reusing the stud is prohibited due to the wear of “micro encapsulation” and potential thread wear.

Note: The “micro encapsulation” has no impact on the pull-out load capacity of the S-BT fastener. The application temperature range for the “micro encapsulation” is -55 °C up to +150 °C.

The installation temperature of the base material must be > +4 °C (for the curing process of the glue coating).

This summary is intended to be representative of the test(s) carried out. It is not intended to be a full and complete test report.

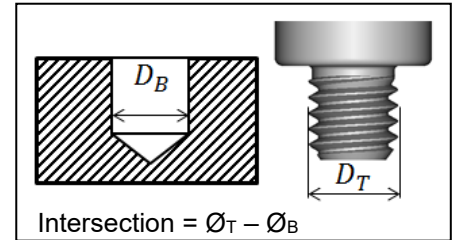

Definition of the thread

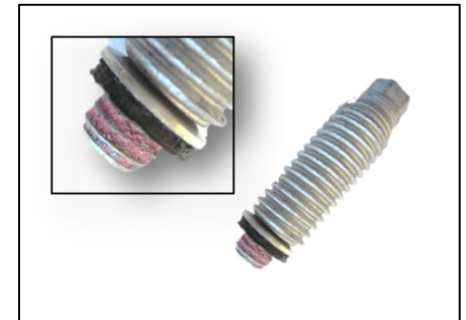

Micro encapsulation on the tapping thread of the S-BT fastener



Polished cut image: activated Micro encapsulation on the tapping thread of the S-BT fastener

5.9 S-BT-ER and S-BT-EF screw-in threaded studs for electrical connections

Fasteners

S-BT-ER M10/15 SN 6
 S-BT-ER W10/15 SN 6
 S-BT-EF M10/15 AN 6
 S-BT-EF W10/15 AN 6

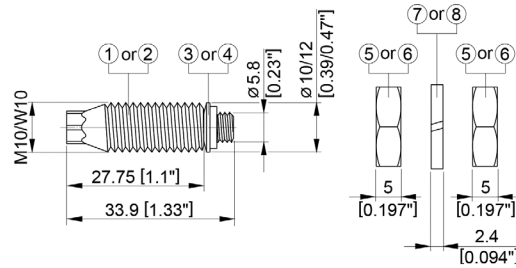

S-BT-ER M8/15 SN 6
 S-BT-EF M8/15 AN 6

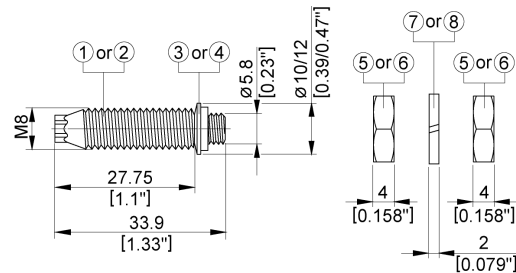

S-BT-ER M10 HC 120
 S-BT-ER W10 HC AWG4/0
 S-BT-EF M10 HC 120
 S-BT-EF W10 HC AWG4/0

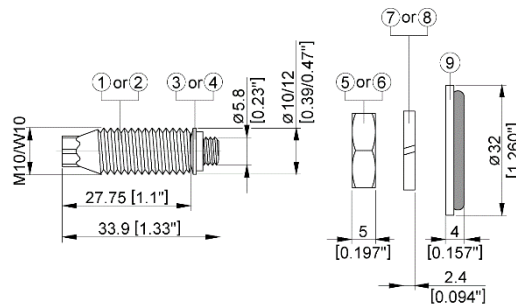

Report No. 17-IK-0093.S02: Suitability of Hilti S-BT-ER and S-BT-EF threaded studs as connection point in protective grounding and earthing circuits and for lighting protection; Electrosuisse, Fehraltorf, Switzerland; July 2017

Report No. 17-IK-0021.S04: Suitability of Hilti S-BT-EF/-ER M10 HC 35, ...W10 AWG2 and S-BT-EF/-ER M10 HC 120, ..W10 AWG4/0 threaded studs as connection point in protective grounding and earthing circuits and for lighting protection; Electrosuisse, Fehraltorf, Switzerland; August 2018

Test Report No. FRM-1648, FRM-1649, FRM-1650
 Dehn + Söhne GmbH + Co.KG., Neumarkt, Germany; March 2017

Test Report No. FRM-1795
 Dehn + Söhne GmbH + Co.KG., Neumarkt, Germany; June 2018

Test Report No. FRM-1689
 Dehn + Söhne GmbH + Co.KG., Neumarkt, Germany; June 2017

Test Report No. FRM-1798 and PAM-1834
 Dehn + Söhne GmbH + Co.KG., Neumarkt, Germany; May 2018 July 2018

Test Report No. FRM-1689; Dehn + Söhne GmbH + Co.KG., Neumarkt, Germany; June 2017

UL-listing (File E257069)

5.9.1 Effect of S-BT-ER / S-BT-EF studs on integrity of pipe flange

Installation of a Hilti S-BT-ER / S-BT-EF threaded stud is not expected to have negative influence on the integrity of flanged pipe joints made from typical ductile steel materials, when installed in the center of the radial or flat face of the flange ring between two bolts.

Hilti's recommendations for edge distance, spacing, minimum flange diameter and minimum base material thickness, as well as Hilti's printed literature, must be considered during design and installation.

- Outer diameter of pipe flange is
 - greater than or equal to 150 mm (6 inches) for installation in the radial face
 - greater than or equal to 100 mm (4 inches) for installation in the flat face
- Minimum edge distance = 6mm
- Minimum pipe flange thickness = 12 mm (installation in radial flange face)
- Minimum pipe flange thickness = 6 mm (installation in flat flange face)
- S-BT-ER / S-BT-EF installed on center of pipe flange and between 2 tension bolts

Only Type A cable connections are allowed to be installed in pipe flanges. Type B cable connections are not suitable for this application.

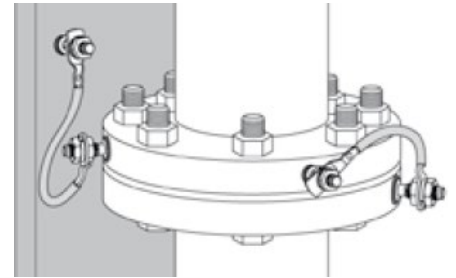

Functional and protective bonding of pipes
(outer diameter of installed surface \geq 150mm)

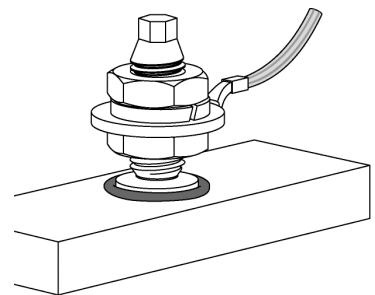

Type A cable connection

5.9.2 Permanent current

For permanent current (leakage current) due to static charge built up in pipes or when closing an electrical circuit.

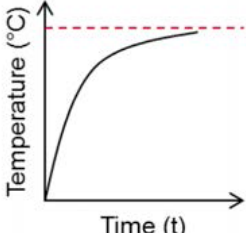
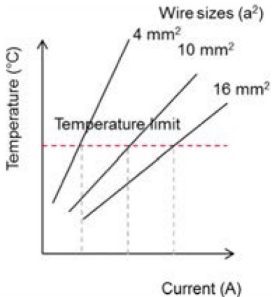
Test standard	Requirements or Test criteria
IEC 60947-7-1 IEC 60947-7-2	<p>The temperature of the fastening point should not exceed the limits of the cable under permanent current, e.g. 45 °C for PVC cables.</p> <p>Test duration: till stable temperature is reached.</p> <div style="display: flex; justify-content: space-around;">   </div>

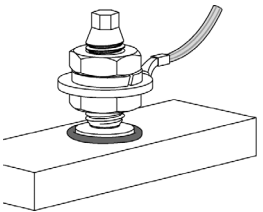
Tested configuration	Fasteners
 <p>Single point connection, Type A</p>	<p>S-BT-ER M10/15 SN 6 S-BT-ER W10/15 SN 6 S-BT-EF M10/15 AN 6 S-BT-EF W10/15 AN 6 S-BT-ER M8/15 SN 6 S-BT-EF M8/15 AN 6</p>

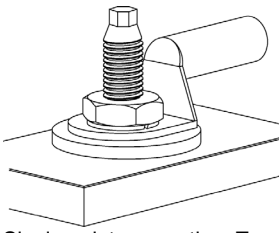
 <p>Single point connection, Type B</p>	<p>S-BT-ER M10 HC 120 S-BT-ER W10 HC AWG4/0 S-BT-EF M10 HC 120 S-BT-EF W10 HC AWG4/0</p>
--	---

Conclusions:

- Recommended maximal cross section of connected cable according **IEC 60947-7-2 and IEC 60947-7-1**:
 - 10 mm² (8 AWG) copper (tested permanent current $I_{th} = 57$ A)
 - 120 mm² (4/0 AWG) copper (tested permanent current $I_{th} = 269$ A)
- Fastening of thicker cable is acceptable, if the maximum allowable permanent current I_{th} is not exceeded and the provisions on cable lug thickness t_{cl} are observed.

5.9.3 Short circuit current

For discharging short circuit current while protecting electrical equipment or earth / ground cable trays and ladders.

Test standards	Requirements or Test criteria
IEC 60947-7-1 IEC 60947-7-2	A grounding connection must be capable of withstanding a high test current (I_{test}) for an exposure time of 1 second. $I_{test} = A_{cable} [mm^2] \times 120 [A/mm^2]$ where A_{cable} = cross sectional area of the attached cable, exposure time 1 second i.e. for wire size 10 mm ² , a current of 1200 A for 1 sec

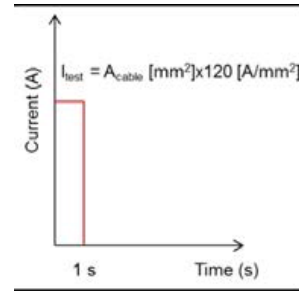

UL 467	A grounding connection must be capable of withstanding a high test current (I_{test}) for an exposure time of 4 sec (10 AWG), 6 sec (2 AWG) or 9 sec (4/0 AWG).
--------	---

Fasteners	
<p>Single point connection, Type A</p>	S-BT-ER M10/15 SN 6
	S-BT-ER W10/15 SN 6
	S-BT-EF M10/15 AN 6
	S-BT-EF W10/15 AN 6
	S-BT-ER M8/15 SN 6
	S-BT-EF M8/15 AN 6

<p>Single point connection, Type B</p>	S-BT-ER M10 HC 120
	S-BT-ER W10 HC AWG4/0
	S-BT-EF M10 HC 120
	S-BT-EF W10 HC AWG4/0

Tested configuration	Test results		
	Short circuit current I_{cw}	Exposure time t_d	Result
<p>Single point connection, Type A</p>	1.20 kA (IEC) 0.75 kA (UL)	1 s	pass
		4 s	
<p>Single point connection with Hilti standoff adapter M10, Type B</p>	1.20 kA (IEC)	1 s	pass

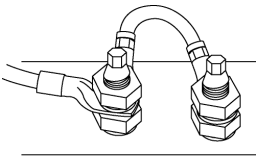
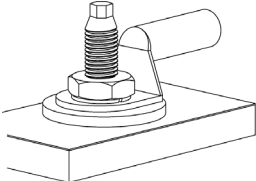
Tested configuration	Test results		
	Short circuit current I_{cw}	Exposure time t_d	Result
 Double point connection, Type A	1.92 kA (IEC)	1 s	pass
 Single point connection, Type B	4.20 kA (IEC)	1 s	pass
	3.90 kA (UL)	6 s	
	14.40 kA (IEC)	1 s	pass
	10.10 kA (UL)	9 s	

Conclusions:
Single point connection:

- Recommended maximal cross section of connected cable according **IEC 60947-7-2 and IEC 60947-7-1**:
 - 10 mm² (8 AWG) copper (tested short circuit current I_{cw} = 1.20 kA for 1 s)
 - 120 mm² (4/0 AWG) copper (tested short circuit current I_{cw} = 14.40 kA for 1 s)
- according **UL 467**:
 - 10 AWG copper (tested short circuit current I_{cw} = 0.75 kA for 4 s)
 - 2 AWG copper (tested short circuit current I_{cw} = 3.90 kA for 6 s)
 - 4/0 AWG copper (tested short circuit current I_{cw} = 10.10 kA for 9 s)
- Fastening of thicker cable is acceptable, if the maximum short circuit current I_{cw} and the exposure time is not exceeded and the provisions on cable lug thickness t_d are observed.

Double point connection:

- Recommended maximal cross section of connected cable according **IEC 60947-7-2 and IEC 60947-7-1**:
 - 16 mm² (6 AWG) copper (tested short circuit current I_{cw} = 1.92 kA for 1 s)
- Fastening of thicker cable is acceptable, if the maximum short circuit current I_{cw} and the exposure time is not exceeded and the provisions on cable lug thickness t_d are observed

5.9.4 Lightning current

For high temporary current due to lightning.

Test standards	Requirements or Test criteria
IEC 62561-1	Electrical test with stress of 3 times 50 kA or 100 kA (signal form 10/350 μ s) lightning current as follows: <ul style="list-style-type: none"> • Classification N $I_{imp} = 50 \text{ kA} \pm 10 \%$, $W/R = 0.625 \text{ MJ}/\Omega \pm 35 \%$, $t_d \leq 5 \text{ ms}$ • Classification H $I_{imp} = 100 \text{ kA} \pm 10 \%$, $W/R = 2.5 \text{ MJ}/\Omega \pm 35 \%$, $t_d \leq 5 \text{ ms}$
	<ul style="list-style-type: none"> • Conditioning / ageing of the test samples • Test with three lightning impulse currents • Evaluation of mechanical strengths of test samples • Measurement of the contact resistance • Measurement of the loosening torque
Fasteners	
Single point connection, Type A	S-BT-ER M10/15 SN 6
	S-BT-ER W10/15 SN 6
	S-BT-EF M10/15 AN 6
	S-BT-EF W10/15 AN 6
	S-BT-ER M8/15 SN 6
	S-BT-EF M8/15 AN 6
Single point connection, Type B	S-BT-ER M10 HC 120
	S-BT-ER W10 HC AWG4/0
	S-BT-EF M10 HC 120
	S-BT-EF W10 HC AWG4/0

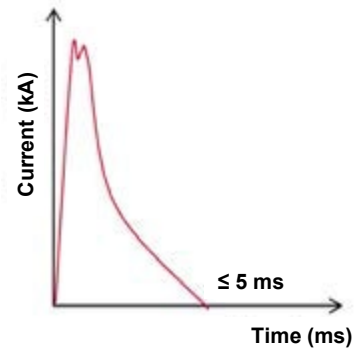

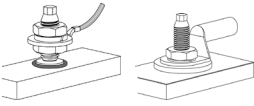
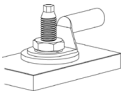
Tested configuration	Test results				
Classification N Single point connection Type A Type B 	Current I_{imp}	Specific energy W/R	Exposure time t_d	Contact resistance R_c	Result
	50 kA	$< 0.844 \text{ MJ}/\Omega$ $> 0.406 \text{ MJ}/\Omega$	1 ms	$< 1 \text{ m}\Omega$	pass
Classification H Single point connection Type B 	Current I_{imp}	Specific energy W/R	Exposure time t_d	Contact resistance R_c	Result
	100 kA	$< 3.38 \text{ MJ}/\Omega$ $> 1.63 \text{ MJ}/\Omega$	1 ms	$< 1 \text{ m}\Omega$	pass

Conclusions:

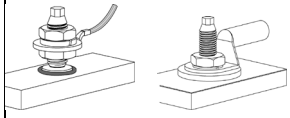
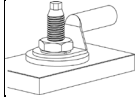
Based on IEC 62561-1:			
Classification	Exposure time	Fastener	Connection configuration
Classification N $I_{imp} \leq 50 \text{ kA}$	1 ms	S-BT-ER M10/15 SN 6 S-BT-ER W10/15 SN 6 S-BT-EF M10/15 AN 6 S-BT-EF W10/15 AN 6 S-BT-ER M8/15 SN 6 S-BT-EF M8/15 AN 6 S-BT-ER M10 HC 120 S-BT-ER W10 HC AWG4/0 S-BT-EF M10 HC 120 S-BT-EF W10 HC AWG4/0	Single point connection: Type A Type B 
			Single point connection: Type B 
Classification H $I_{imp} \leq 100 \text{ kA}$			

5.10 Corrosion resistance

5.10.1 Selection of a suitable fastener

If a fastening has to be perfectly satisfactory and reliable for its entire service life, all surrounding conditions must be ascertained before a suitable fastener can be selected.

Therefore, it is necessary to take into account where the parts are installed, indoor or outdoor. For outdoor applications, a distinction is made between rural, urban, industrial and marine atmospheres. Nevertheless, there are special applications like waste water treatment plants, industrial installations, road tunnels and swimming pools. In view of this, each application must be evaluated separately and the findings must be considered when selecting a material with the required corrosion behavior or a system that provides adequate corrosion protection.

When material combinations are used, an evaluation of their electrochemical behavior has to be performed to avoid contact corrosion.

Note:

- The information in the following section may be of assistance as it provides some important points that aid selection. The table, however, cannot cover all individual aspects for each application.
- The ultimate decision on the required corrosion protection must be made by the customer. Hilti accepts no responsibility regarding the suitability of a product for a specific application, even if informed of the application conditions. The tables are based on an average service life for typical applications. For metallic coatings, e.g. zinc layer systems, the end of lifetime is the point at which red rust is visible over a large fraction of the product and widespread structural deterioration can occur – the initial onset of rust may occur sooner.

		Fastener	
		Carbon steel	Stainless steel
		S-BT-MF	S-BT-MR
		S-BT-MF MT	S-BT-MR MT
		S-BT-GF	S-BT-GR
		S-BT-GF NG	S-BR-GR NG
		S-BT-EF	S-BT-ER
		Duplex-coated carbon steel	A4 AISI 316
Coating / material			
Environmental conditions	Fastened part		
Dry indoor	Steel (zinc-coated, painted), aluminum, stainless steel	■	■
Indoor with temporary condensation	Steel (zinc-coated, painted), aluminum, stainless steel	■	-
Outdoor with low pollution	Steel (zinc-coated, painted), aluminum, stainless steel	□ ¹⁾	-
Outdoor with moderate concentration of pollutants	Steel (zinc-coated, painted), aluminum, stainless steel	□ ¹⁾	-
Coastal areas	Steel (zinc-coated, painted), aluminum, stainless steel	-	-
Outdoor, areas with heavy industrial pollution	Steel (zinc-coated, painted), aluminum, stainless steel	-	-
Close proximity to roads	Steel (zinc-coated, painted), aluminum, stainless steel	-	-
Special applications		Consult experts	

■ = expected lifetime of S-BT fasteners made from this material is typically satisfactory in the specified environment based on the typically expected lifetime of a building.

□ = a decrease in the expected lifetime of non-stainless fasteners in these atmospheres must be taken into account (≤ 25 years). Higher expected lifetime needs a specific assessment.

- = S-BT fasteners made from this material are not suitable in the specified environment. Exceptions need a specific assessment.

¹⁾ From a technical point of view, duplex coatings are suitable for outdoor environments with certain lifetime and application restrictions. This is based on long-term experience with these materials as reflected e.g. in the corrosion rates for Zn given in the ISO 9224:2012 (corrosivity categories, C-classes).

Important notes:

National or international codes, standards or regulations, customer and/or industry specific guidelines must be independently considered and evaluated. These guidelines apply to atmospheric corrosion only. Special types of corrosion, such as crevice corrosion must be independently evaluated.

The tables published in this brochure describe only a general guideline for commonly accepted applications in typical atmospheric environments.

Suitability for a specific application can be significantly affected by localized conditions, including but not limited to:

- Elevated temperatures and humidity
- High levels of airborne pollutants
- Direct contact with corrosive products, such as found in some types of chemically-treated wood, waste water, concrete additives, cleaning agents, etc.
- Direct contact to soil, stagnant water
- Direct contact to fresh/young concrete (less than 28 days old)
- Electrical current
- Contact with dissimilar metals
- Confined areas, e.g. crevices
- Physical damage or wear
- Extreme corrosivity due to combined effects of different influencing factors
- Enrichment of pollutants on the product
- Nature of fastening part: fastener must be made of a more noble material or the same material than the fastened part

5.10.2 Galvanic (contact) corrosion

Galvanic corrosion refers to corrosion damage where two dissimilar metals have an electrically conducting connection and are in contact with a common corrosive electrolyte.

Generally, the less noble metal will be dissolved (anodic metal dissolution), whereas the more noble part is not attacked by corrosion (serves only as the cathode for oxygen reduction). Where galvanic corrosion takes place, the rate of corrosion of the less noble metal is higher than it would be in a free corroding environment without contact to another metal.

Galvanic corrosion can be avoided by the right choice of material combinations. To minimize galvanic corrosion, the difference in free corrosion potential between the materials should be as low as possible, and/or the surface ratio of less noble metal to nobler metal should be very high. The free corrosion potential depends on the standard potential, a given thermodynamic value for each metal and the corrosive environment.

As a general rule of thumb, a fastener should always be made of the same or a more noble metal than the part to be fastened in order to prevent failure of the fastener. The fastener typically has the smaller surface area.

The following table shows the impact of galvanic corrosion under atmospheric **outdoor conditions** for various material combinations.

In **dry indoor applications** contact corrosion can be neglected and usually there are no susceptible material combinations.

Fastened part (large area)	Fastener (small area)	
	Carbon steel (Duplex-coated) S-BT-MF S-BT-MF MT S-BT-GF S-BT-GF NG S-BT-EF	Stainless steel S-BT-MR S-BT-MR MT S-BT-GR S-BT-GR NG S-BT-ER
Electrogalvanized	□	□
Hot-dip galvanized	□	□
Aluminum	■	□
Structural or cast steel	■	□
Stainless steel (CrNi or CrNiMo)	■	□
Tin	■	□
Copper	■	□
Brass	■	□

- No impact on lifetime
- moderate impact on lifetime, technically accepted in many cases
- strong impact on lifetime

Impact on lifetime of the S-BT fastener by galvanic (contact) corrosion

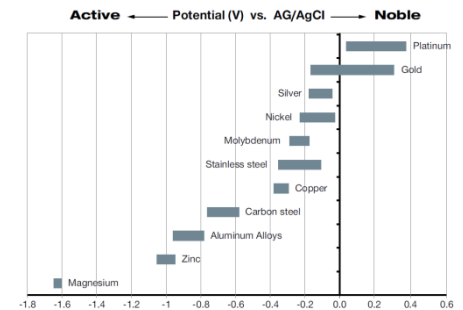
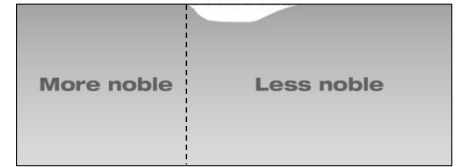

Corrosion potential of various metals in sea water



This is a typical case of contact corrosion. Zinc-plated carbon steel (washer) and stainless steel (screw and part) were used together. The surface area of the more noble metal – the stainless steel – is larger, causing strong corrosion of the washer.

5.10.3 Carbon steel S-BT studs

General comments

The coating of the carbon steel S-BT fasteners consists of an electroplated Zn-alloy for cathodic protection and a top coat for chemical resistance (Duplex-coating). The thickness of the coating is 35 µm. The use of this coating is limited to the corrosion category C1, C2 and C3 according the standard EN ISO 9223. For higher corrosion categories stainless steel fasteners should be used.

Thanks to extensive research in close cooperation with renowned universities and laboratories, designers can trust and rely on the multilayer coating for S-BT.

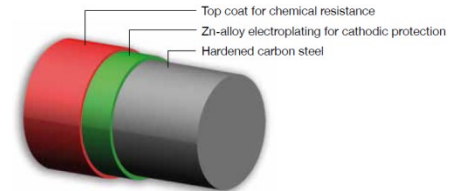

Duplex-coating on carbon steel S-BT fasteners

Indoor applications	
	Dry indoor environments (heated or air-conditioned areas) without condensation, e.g. office buildings, schools
	Indoor environments with temporary condensation (unheated areas without pollutants), e.g. storage sheds
Outdoor applications	
	Outdoor, rural or urban environment with low pollution Large distance (> 10 km) from the sea
	Outdoor, rural or urban environment with moderate concentration of pollutants and/or salt from sea water Distance from the sea 1-10 km

Environmental conditions for usage of coated carbon steel S-BT studs

Test concept

Laboratory and field tests are performed to assess the expected lifetime and technical safety aspects for fasteners. The duplex coating on the S-BT was tested in neutral salt spray according to DIN EN ISO 9227, which is the most commonly used accelerated corrosion test for corrosion assessment. This test is suitable for quality assessment but does not reflect real environmental conditions. In contrast, cyclic corrosion tests like ISO 16701 reproduce and accelerate corrosion mechanisms that occur under real environmental conditions. This test is well adapted for lifetime assessment under moderate atmospheric conditions. The fasteners are subjected through cycled climate conditions such as temperature variations, humidity and dry periods as well as corrosion attack through salt. Results of laboratory tests are verified by mid- and long term field tests in natural climatic conditions.

During the setting process, the fastener is subjected to strong impacts. To ensure that the corrosion resistance of the S-BT remains intact, Hilti performs all corrosion tests on S-BT in mounted condition and the fasteners are installed in steel plates with the necessary tools.



Prepared S-BT fastenings



Removed S-BT fasteners after 12 weeks EN ISO 16701 cyclic corrosion test. No visible corrosion.

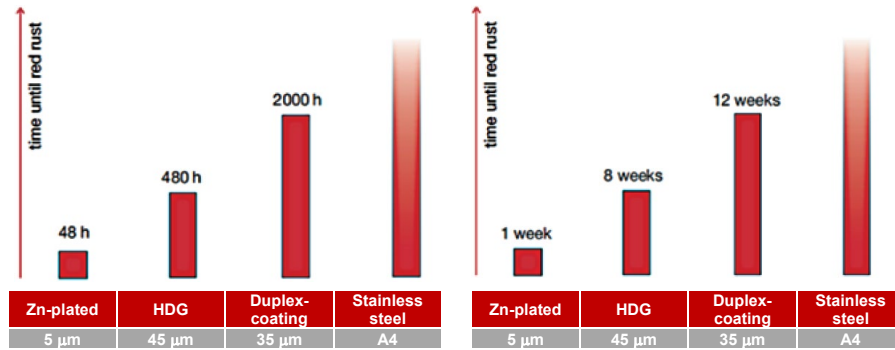

Neutral salt spray test

S-BT studs with duplex-coating are subjected to a neutral salt spray test according to DIN EN ISO 9227. Under this test, the corrosion resistance of S-BT studs with duplex-coating is significantly higher as compared to hot dip galvanized (HDG) systems with at least 45 µm coating thickness. Grade A4 stainless steel S-BT studs remain stable under this test and withstand corrosion due to passive surface.

Cyclic corrosion test

The cyclic corrosion test gives a more realistic assessment of corrosion resistance under natural environments. Under this test, the corrosion resistance of S-BT studs with duplex-coating is comparable and even higher than HDG systems. Grade A4 stainless steel S-BT studs also remain stable under this cyclic corrosion test.

Test results

On the S-BT studs with aluminum sealing washer no corrosion was found after 12 weeks in the cyclic corrosion test. All aluminum sealing washers have adequately sealed the drilled holes over the test period of time. There was no visible corrosion in the bore holes.

Conclusions

- In the ISO 16701 test, the material combination of aluminum sealing washer and the duplex-coating of the carbon steel S-BT studs has been found to be optimal.
- After 12 weeks in the cyclic climate chamber the coating system of the carbon steel S-BT studs showed no tendencies to contact corrosion. The combination is suitable for use in C1, C2 and C3 environment acc. DIN EN ISO 9223:2012
- No corrosion was found in the drilled holes. This is strong evidence that the sealing washer provides an effective seal.





5.10.4 Stainless steel S-BT studs

General comments

The S-BT stainless studs are made from the duplex stainless steel type 1.4462. This grade of stainless steel is classified as corrosion resistance class IV according to DIN EN 1993-1-4:2015, which makes the material suitable for aggressive environments like in coastal and offshore applications. The microstructures of duplex stainless steels consist of a mixture of austenite and ferrite phases. Compared to the austenitic stainless steel grades, duplex stainless steels are magnetic. The surface of the S-BT stainless steel fasteners is zinc plated (anti-friction coating) in order to reduce the thread forming torque when the stud is screwed in into the base material.

The Hilti X-BT system was developed by Hilti Corporation especially for applications on steel structures that form part of oil and gas production

facilities, in shipbuilding and in general steel construction. Therefore, comprehensive corrosion tests (electrochemical tests, field test) have been performed on the X-BT stud. The stainless-steel S-BT studs are intended to be used for the same applications and the studs are made of the same material as the shank of the X-BT fastener, duplex steel type 1.4462.

Outdoor applications	
	Outdoor, rural or urban environment with low pollution Large distance (> 10 km) from the sea
	Outdoor, rural or urban environment with moderate concentration of pollutants and/or salt from sea water Distance from the sea 1-10 km
	Coastal areas Distance from the sea < 1 km
	Outdoor, areas with heavy industrial pollution Atmospheric SO ₂ concentration > 10 µg/m ³ as yearly average (e.g. close to polluting plants)
	Close proximity to roadways treated with de-icing salts, Distance from roadways < 10 m

Environmental conditions for usage of stainless steel S-BT studs.

Test concept

The corrosion behavior of the X-BT fastener was assessed by MPA Stuttgart in 2009. Based on these investigations, MPA Stuttgart assessed the corrosion behavior of the stainless-steel S-BT fasteners.

The MPA report evaluates and assesses the S-BT stainless studs in terms of the following corrosion topics:

- Evaluation and assessment of atmospheric corrosion
 - Pitting or crevice corrosion
 - Stress corrosion cracking
 - Bimetallic corrosion
- Corrosion resistance of stainless steels on the basis of their composition
- Long-term exposure tests in maritime atmospheres
- Electrochemical tests

Test results

- On the basis of the investigations mentioned above, MPA Stuttgart assumed that the stainless S-BT studs have very good resistance to corrosion, even in atmospheres containing chlorides and are comparable to that of the X-BT.
- Tests at MPA Stuttgart confirmed high resistance to pitting or crevice corrosion.
- Tests carried out at the University of Leoben showed that the material also has good resistance to stress corrosion cracking even in highly aggressive media.

Conclusions

Hilti S-BT stainless fasteners made from stainless steel offer excellent corrosion resistance in atmospheres containing chloride ions, i.e. coastal areas and areas near roads treated with de-icing salts.

Based on the examinations from MPA Stuttgart, the estimated life time in typical atmospheres, from a corrosion-specific point of view, is at least 40 years.

5.10.5 Conductivity disc of S-BT-ER / -EF electrical connectors

The conductivity disc of the S-BT-ER / -EF HC is made from copper alloy CuSn8 with a tin-coating on the surface and a sealing ring on the bottom side. The copper alloy is classified as largely insensitive to stress corrosion cracking and pitting corrosion. The conductivity disc is designed for use in corrosion categories C1 - C5 according to EN ISO 9223. It is therefore suitable for use in aggressive environments like coastal and offshore applications.

5.10.6 Standoff Adapters

Standoff adapters made of duplex-coated carbon steel

The coating of the carbon steel standoff adapters consists of an electroplated Zn-alloy for cathodic protection and a top coat for chemical resistance (Duplex-coating). The use of this coating is limited to the corrosion category C1, C2 and C3 according to the standard EN ISO 9223. For higher corrosion categories stainless steel standoff adapters should be used.

Standoff adapters made of stainless steel

The stainless steel standoff adapters are made from the stainless steel type 1.4401 (AISI 316). This grade of stainless steel is classified as corrosion resistance class III according to DIN EN 1993-1-4:2015, which makes the material suitable for outdoor applications and atmospheres containing chloride ions, i.e. coastal areas and areas near roads treated with de-icing salts.

5.10.7 Hilti Coupler RC-MF and RC-MR

Hilti Coupler RC-MF made of duplex-coated carbon steel

The coating of the carbon steel Hilti Coupler RC-MF consists of an electroplated Zn-alloy for cathodic protection and a top coat for chemical resistance (Duplex-coating). The use of this coating is limited to the corrosion category C1, C2 and C3 according to the standard EN ISO 9223. For higher corrosion categories stainless steel standoff adapters should be used.

Hilti Coupler RC-MR made of stainless steel

The stainless steel Hilti Coupler RC-MR are made from the stainless steel type 1.4401 (AISI 316) or 1.4404 (AISI 316L). These grades of stainless steel are classified as corrosion resistance class III according to DIN EN 1993-1-4:2015, which makes the materials suitable for outdoor applications and atmospheres containing chloride ions, i.e. coastal areas and areas near roads treated with de-icing salts.

5.10.8 X-FCM and X-FCM NG grating fasteners

X-FCM grating fasteners made of zinc coated carbon steel

The coating of the carbon steel grating fasteners consists of an electroplated zinc coating. The use of this coating is limited to the corrosion category C1 according to the standard EN ISO 9223. For higher corrosion categories duplex coated grating fasteners or stainless steel grating fasteners should be used.

X-FCM-M and X-FCM-M NG grating fasteners made of duplex-coated carbon steel

The coating of the X-FCM-M and X-FCM-M NG carbon steel grating fasteners consists of an electroplated Zn-alloy for cathodic protection and a top coat for chemical resistance (duplex-coating). The intended use of this coating is limited to the corrosion category C1, C2 and C3 according to the standard EN ISO 9223 (indoors, mildly corrosive environment). The carbon steel grating fasteners are to be used for fastening gratings made of coated or galvanized carbon steel or gratings made of reinforced fibreglass.

Note: The fasteners are not for use in marine atmosphere or in heavily polluted environment.

X-FCM-R and X-FCM-R NG grating fasteners made of stainless steel

The X-FCM-R and X-FCM-R NG stainless steel grating fasteners are made from the stainless-steel type 1.4404, which is equivalent to AISI 316L (A4) steel grade. This grade of stainless steel is classified in the corrosion resistance class III according to DIN EN 1993-1-4:2015, which makes the material suitable for aggressive environments like in marine, offshore, petrochemical, caloric (coal, oil) power plants, etc. applications. The stainless-steel grating fasteners are to be used for fastening gratings made of stainless steel or gratings made of reinforced fibreglass.

Note: The fasteners are not for use in automobile tunnels, swimming pools or similar environments.

5.11 Fire resistance

Test Report No. 20161614 and No. 20170384
 MPA Dresden GmbH – IMO Recognized Test Laboratory (2017) [1] and [2]

General comments

When using Hilti S-BT fasteners in combination with fire rated boundaries in Shipbuilding facilities, the effect of the fastener on the mechanical resistance of the steel base material (bulkheads, decks) has to be considered. Furthermore, the behavior of the Hilti S-BT screw-in threaded studs under fire conditions, whilst supporting a load, has to be checked.

Test concept

The tests were performed according the requirements of IMO Resolution MSC.307(88), Fire Test Procedure Code, 2010, part 3 [3]. In order to test the S-BT fastener in the most onerous manner, a “A-0” class bulkhead (uninsulated) was tested at MPA Dresden.

For the test, two bulkhead sizes were used.

The big A-0 bulkhead is a 2980 mm square. The plate of the bulkhead consists of a 5 mm thick steel plate with 65 x 65 x 6 mm L-stiffener along the vertical edges. The constructional details of the test specimen used are given in the corresponding test report [1] and Figure 1.

The small A-0 bulkhead is a 980 mm square and is fabricated in two halves. Viewed from the unexposed face the left-hand side of the bulkhead consists of a 3 mm steel plate with a Bulb flat 80 x 5.0 stiffener along the vertical edge. The right-hand side of the bulkhead consists of a 6 mm steel plate with a Bulb flat 80 x 5.0 stiffener along the vertical edge. There is also a central stiffener (Bulb flat 80 x 5.0). The constructional details of the test specimen used are given in the corresponding test report [2] and Figure 2.

The bulkheads were installed such that the stiffeners and the S-BT studs were on the unexposed face of the specimen.

A total of eight S-BT threaded studs (big bulkhead) and ten S-BT threaded studs (small bulkhead) were fitted to the bulkhead and were subjected to either a tension or shear load.

The loading details of each S-BT stud and an overview of the selected test program are given in Table 1 and Table 2.



Figure 1: Test facility for fire test (big bulkhead)



Figure 2: Test facility for fire test (small bulkhead)

Stud #	Force [kN]	Type of force	S-BT Type	Base material thickness [mm]
1	0.53	Tension	S-BT-MR M8/15 SN6	6.0 (L-stiffener)
2	0.51	Tension	S-BT-MR M8/15 SN6	5.0 (Plate)
3	0.52	Tension	S-BT-MF M8/15 AN6	5.0 (Plate)
4	0.52	Tension	S-BT-MF M8/15 AN6	6.0 (L-stiffener)
5	0.50	Shear	S-BT-MR M8/15 SN6	6.0 (L-stiffener)
6	0.50	Shear	S-BT-MR M8/15 SN6	5.0 (Plate)
7	0.50	Shear	S-BT-MF M8/15 AN6	5.0 (Plate)
8	0.50	Shear	S-BT-MF M8/15 AN6	6.0 (L-stiffener)

Table 1: Test program of the big bulkhead 2980 mm x 2980 mm

Stud #	Force [kN]	Type of force	S-BT Type	Base material thickness [mm]
1	0.53	Tension	S-BT-MR M8/15 SN6	Bulb Flat 80 x 5.0
2	0.26	Tension	S-BT-MR M8/15 SN6	3.0 (Plate) (drill through hole)
3	0.52	Tension	S-BT-MF M8/15 AN6	6.0 (Plate)
4	0.52	Tension	S-BT-MF M8/15 AN6	Bulb Flat 80 x 5.0
5	0.50	Shear	S-BT-MR M8/15 SN6	Bulb Flat 80 x 5.0
6	0.25	Shear	S-BT-MR M8/15 SN6	3.0 (Plate) (drill through hole)
7	0.25	Shear	S-BT-MF M8/15 AN6	3.0 (Plate) (drill through hole)
8	0.50	Shear	S-BT-MR M8/15 SN6	6.0 (Plate)
9	0.50	Shear	S-BT-MF M8/15 AN6	6.0 (Plate)
10	0.50	Shear	S-BT-MF M8/15 AN6	Bulb Flat 80 x 5.0

Table 2: Test program of the small bulkhead 980 mm x 980 mm

According to [3], for all “A” class divisions the following requirements shall be satisfied for the minimum test duration of 60 min.

- Flaming: there shall be no flaming and smoke on the unexposed face
- Gap gauges: it shall not be possible to enter the gap gauge into any opening in the specimen
- Stability of the test specimen

For “A-0” class bulkheads the average unexposed-face temperature rise is not applicable.

In addition to the requirements above a further requirement is defined:

- The installed S-BT studs shall maintain their loads (tension or shear) for a period of 60 minutes

During the test the average furnace temperature, the unexposed surface temperature adjacent to the installed S-BT studs and the deflection of the bulkhead were measured and recorded.

The test setup, measurements and the results are described in detail in [1] and [2].

Test results

For the tests, S-BT-MR M8/15 (stainless steel) and S-BT-MF M8/15 (carbon steel) were used. The threaded tip of the S-BT studs and the sealing washer (area A in Figure 3) is identical for all dimensions. Only the threads (e.g. M8, M10, W10) for attachment of supported materials (area B in Figure 3) are different. For this reason, S-BT studs with thread M8 were chosen for the tests in order to adopt the test results to the bigger threads M10 / W10.

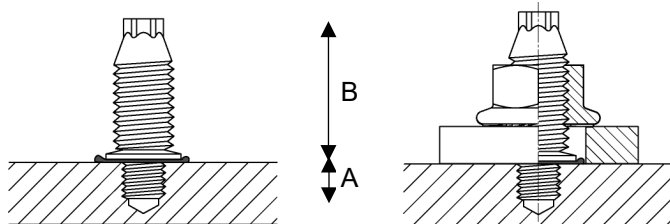

Figure 3: Geometry of S-BT studs

Stability of the test specimen was given during the 60 test minutes. All installed S-BT studs were able to maintain their loads (ref. to Table 1 and Table 2) for a period of 60 minutes whilst the bulkhead was subjected to a test, which utilized the conditions given in IMO Resolution MSC.307(88), FTP Code, 2010 for “A-0” bulkheads. There was no occurrence of any flaming or smoke on the unexposed surface of the specimen during the test. In the test specimen there were no openings or cracks visible during the whole test period.

Conclusions

Both bulkheads passed the performance criteria of IMO Resolution MSC.307(88), FTP Code, 2010 for “A-0” bulkheads. The installed S-BT studs didn’t affect the fire resistance of steel bulkheads and the studs were able to maintain their loads for a period of 60 minutes.

Based on the test results the use of S-BT studs for applications in fire rated boundaries on ships can be recommended.

Recommended loads for applications in fire rated boundaries

	S-BT-_____6	
Base material	Steel with yield strength R_{eH} $235 \text{ MPa} \leq R_{eH} \leq 355 \text{ MPa}$ (ordinary strength e.g. S235, Grade A up to higher strength e.g. S355, Grade AH36)	
Drill hole type and base material thickness	Pilot hole, $t_{II} \geq 6 \text{ mm}$ [0.24"] Drill through hole, 5 mm [0.20] $\leq t_{II} < 6 \text{ mm}$ [0.24"]	Drill through hole $3 \text{ mm} \leq t_{II} < 5 \text{ mm}$
Tension, R60, $N_{rec,fi}$ [kN/lb]	0.50 / 112	0.25 / 56
Shear, R60 $V_{rec,fi}$ [kN/lb]	0.50 / 112	0.25 / 56

Conditions for recommended loads:

- Use S-BT-MR and S-BT-MF (multipurpose fastening) only with the attached Hilti serrated flange nuts M8, M10, W10 (© or © refer to section 3.1.1)
- S-BT studs installed on the unexposed face of the bulkhead
- Global factor of safety Ω_{fi} for static pull-out and static shear = 1.0.
- Minimum edge distance = 6 mm [0.24"], spacing $\geq 18 \text{ mm}$ [0.709"]
- Redundancy (multiple fastening) must be provided.
- If eccentric loading exists (e.g. use of an angle clip), moments caused by off-center loading must be considered.

Literature:

- [1] MPA Dresden: Test Report No. 20170384, MPA Dresden GmbH – IMO Recognized Test Laboratory, Dresden (D), July 20th, 2017
- [2] MPA Dresden: Test Report No. 20161614, MPA Dresden GmbH – IMO Recognized Test Laboratory, Dresden (D), July 21st, 2017
- [3] IMO Resolution MSC.307(88), Fire Test Procedure Code, 2010

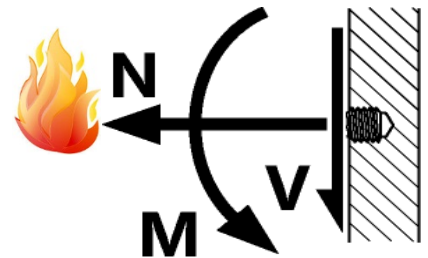
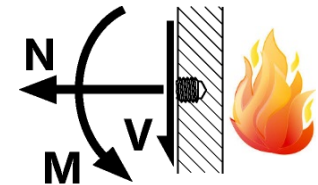

**5.12 Volume swelling of SN 12 sealing washer
(stainless steel S-BT studs)**

(Refer to section 3.1.1 material No. ③)

Chemicals	Volume swell				
	< 20%	20-40%	> 40-60%	> 60-80%	> 80-100%
1. Water at 80°C	■				
2. Sea water	■				
3. Zinc chloride 10%	■				
4. Sodium chloride 15%	■				
5. Hydrochloric acid 10%	■				
6. Acetic acid	■				
7. Acrylonitrile				■	
8. Aniline				■	
9. n-Butyl acetate					■
10. Diethylether		■			
11. Ethanol	■				
12. Glycerol	■				
13. n-Hexane	■				
14. Methanol	■				
15. Methyleneethylketone				■	
16. Nitrobenzene				■	
17. 1-Propanol	■				
18. Oil (ASTM-1) at 80°C	■				
19. Oil (ASTM-2) at 80°C		■			
20. Oil (ASTM-3) at 80°C		■			
21. Reference fuel B (isooctane/toluene, 70/30)				■	
22. Reference fuel C (isooctane/toluene, 50/50)					■
23. Hydraulic brake fluid	■				
24. Hydraulic brake fluid at 100°C		■			
25. Antifreeze (ethylene glycol/water 50/50) at 125°C		■			

Material: 3.1107 Chloroprene Rubber: ozone and UV resistance
Temperature range: -40°C to +100°C

Volume swelling is a reaction of the material of the washer when it's in contact with the different substances. It's used as a parameter to describe the chemical reaction.

The swelling factor gives an indication of the behavior of the material, but swelling does not lead directly to loss of the sealing property. With an installed stainless steel S-BT stud, the washer is compressed against the base steel.

Without any specific requirement a general guideline is that the washer material is resistant to all substances where the volume swelling value is ≤ 40%.

The table above is valid only for stainless steel S-BT studs.

6 SYSTEM PROGRAM

Designation	Item no.	Product name	Comment	Application	
S-BT-GF M8/7 AN 6	2140527	Threaded stud	use with X-FCM or X-FCM-M grating disc	Grating	
S-BT-GF NG M8/7 AN 6	2302143	Threaded stud	use with X-FCM-M NG grating disc		
S-BT-MF M8/7 AN 6	2139174	Threaded stud	package includes serrated flange nut	Multipurpose	
S-BT-MF M8/15 AN 6	2148618	Threaded stud			
S-BT-MF M10/15 AN 6	2140528	Threaded stud			
S-BT-MF W10/15 AN 6	2139173	Threaded stud			
S-BT-MF MT M8/7 AN 6	2298450	Threaded stud	use with Hilti coupler RC-MF-M8 47/35	Multipurpose	
S-BT-MF MT M10/15 AN 6	2309240	Threaded stud	use with Hilti coupler RC-MF-M10 47/35		
S-BT-GR M8/7 SN 6	2140529	Threaded stud	use with X-FCM-R grating disc	Grating	
S-BT-GR M8/7 SN 6 AL	2140742	Threaded stud			
S-BT-GR NG M8/7 SN 6	2302142	Threaded stud	use with X-FCM-R NG grating disc	Multipurpose	
S-BT-MR M8/7 SN 6	2139172	Threaded stud	package includes serrated flange nut		
S-BT-MR M8/7 SN 6 AL	2140743	Threaded stud			
S-BT-MR M8/15 SN 6	2148612	Threaded stud			
S-BT-MR M8/15 SN 6 AL	2148614	Threaded stud			
S-BT-MR M10/15 SN 6	2140740	Threaded stud			
S-BT-MR M10/15 SN 6 AL	2140744	Threaded stud			
S-BT-MR W10/15 SN 6	2140741	Threaded stud			
S-BT-MR W10/15 SN 6 AL	2140745	Threaded stud			
S-BT-MR MT M8/7 SN 6	2298451	Threaded stud	use with Hilti coupler RC-MR-M8 47/35		
S-BT-MR MT M10/15 SN 6	2205156	Threaded stud	use with Hilti coupler RC-MR-M10 47/35		
S-BT-EF M8/15 AN 6	2186208	Threaded stud	package includes nuts and lock washers		Electrical connection
S-BT-EF M10/15 AN 6	2186204	Threaded stud			
S-BT-EF W10/15 AN 6	2186206	Threaded stud			
S-BT-EF M10 HC 120	2204932	Threaded stud	package includes nuts, lock washers and conductor discs	Electrical connection High Current	
S-BT-EF W10 HC AWG4/0	2206612	Threaded stud			
S-BT-ER M8/15 SN 6	2186207	Threaded stud	package includes nuts and lock washers	Electrical connection	
S-BT-ER M10/15 SN 6	2186203	Threaded stud			
S-BT-ER W10/15 SN 6	2186205	Threaded stud			
S-BT-ER M10 HC 120	2204739	Threaded stud	package includes nuts, lock washers and conductor discs	Electrical connection High Current	
S-BT-ER W10 HC AWG4/0	2206611	Threaded stud			
RC-MF-M8 47/35	2284786	Coupler M8	use with S-BT-MF MT M8/7 AN 6	Multipurpose	
RC-MF-M10 47/35	2284788	Coupler M10	use with S-BT-MF MT M10/15 AN 6		
RC-MR-M8 47/35	2284789	Coupler M8	use with S-BT-MR MT M8/7 SN 6		
RC-MR-M10 47/35	2284787	Coupler M10	use with S-BT-MR MT M10/15 SN 6		
Adapter M8-MF 25	2268526	Standoff adapter	M8: package includes serrated wide flange nut	Fastening on insulated base materials or PFP-coated base materials	
Adapter M8-MF 50	2268527	Standoff adapter			
Adapter M8-MF 75	2268528	Standoff adapter			
Adapter M8-MF 100	2268529	Standoff adapter			
Adapter M8-MR 25	2268522	Standoff adapter			
Adapter M8-MR 50	2268523	Standoff adapter			
Adapter M8-MR 75	2268524	Standoff adapter			
Adapter M8-MR 100	2268525	Standoff adapter			
Adapter M10-MF 50	2281194 *)	Standoff adapter	M10 / W10: package includes adapters only		
Adapter M10-MR 50	2281191 *)	Standoff adapter			
Adapter W10-MF 50	2281192 *)	Standoff adapter			
Adapter W10-MR 50	2281193 *)	Standoff adapter			
Adapter M8-MF 25 + TS-BT 31-74 PFP	2276130	Standoff adapter	package includes adapters, serrated wide flange nut M8 and stepped drill bit for PFP-coating removal		
Adapter M8-MR 25 + TS-BT 31-74 PFP	2276131	Standoff adapter			

Designation	Item no.	Product name	Comment	Application
TS-BT 5.5-74 S	2143137	Stepped drill bit	for base material steel	Grating
TS-BT 5.5-110 S	2201685	Stepped drill bit	For use in combination with the S-CS NG centering spacer	
TS-BT 5.5-74 AL	2143138	Stepped drill bit	for base material aluminum	
TS-BT HC 120/AWG4/0	2204736	Coating removal drill bit	for removal of the coating from the base material	Electrical connection
TS-BT 31-74 PFP	2270470	Stepped drill bit	for removal of the PFP-coating from the base material	Grating
S-CS NG	2310191	Centering spacer	for X-FCM NG system for perpendicular pilot hole drilling and precise location of studs	
S-DG BT M8/7 Short 6	2143260	Depth gauge	for exact setting of the S-BT	
S-DG BT M8/7 Short 6	2279735	Depth gauge	for exact setting of the S-BT-GF NG M8/7 AN 6 and S-BT-GR NG M8/7 SN 6	
S-DG BT M10-W10/15 Long 6	2143261	Depth gauge	for exact setting of the S-BT	
S-DG BT M8/15 Long 6	2148575	Depth gauge	for exact setting of the S-BT	
S-DG BT M10-W10/15 HC 6	2204933	Depth gauge	for exact setting of the S-BT ____ HC ____	
S-CG BT /7 Short 6	2143262	Check gauge	for verification of the stud standoff	
S-CG BT /15 long 6	2143263	Check gauge	for verification of the stud standoff	
S-CG BT HC	2208475	Check gauge	for verification of the stud standoff	
S-BT 1/4" – 5 Nm	2143271	Torque tool	manual torque tool (5 Nm)	
X-BT 1/4" – 8 Nm	2119272	Torque tool	manual torque tool (8 Nm)	
X-BT 1/4" – 20 Nm	2212510	Torque tool	manual torque tool (20 Nm)	
S-NS 13 C 95/3 3/4"	2149244	Nut setter	for serrated flange nut M8	
S-NS 15 C 95/3 3/4"	2149245	Nut setter	for serrated flange nut M10	
S-NS 9/16" C 95/3 3/4"	2149246	Nut setter	for serrated flange nut W10	
S-NS 3/4" C 95/3 3/4"	2268521	Nut setter	for standoff adapters M8 and M10	
Bored Plate MQZ-L9-R	304071	Bored plate	For increasing contact surface and/or centering of channel on standoff adapter	
Bored Plate MQZ-L9-R	304196	Bored plate		

7 APPROVALS

Approvals are subject to continuous changes related to code developments, product portfolio updates and new research results. Current approvals can be downloaded from Hilti website or from the websites of most Certification Bodies.

7.1 Offshore and Shipbuilding applications



- ABS – American Bureau of Shipping
16-HS1550085-PDA
- DNV-GL
TAS00000N6
- LR – Lloyds Register
16/00063
- Russian Maritime Register of Shipping
18.40040.250
- BV – Bureau Veritas
45116/A BV
- RINA Services S.p.A.
FPE278318CS
- China Classification Society CCS
NJ17P2016

7.2 Onshore and Industry applications



- EOTA – European Organisation for Technical Assessment
ETA-20/0530
- ICC-ES – International Code Council - Evaluation Service
ESR-4185
- UL – Underwriters Laboratories
UL-listing (File E257069)